

**CCR CLOSURE PLAN  
MONTICELLO STEAM ELECTRIC STATION  
BOTTOM ASH PONDS  
TITUS COUNTY, TEXAS**

OCTOBER 2016

PREPARED FOR:

**LUMINANT GENERATION COMPANY, LLC**  
1601 Bryan Street (EP-27)  
Dallas, Texas 75201

PREPARED BY:

**PASTOR, BEHLING & WHEELER, LLC**  
5416 Plaza Drive  
Texarkana, Texas 75503  
Texas Engineering Firm No. 4760

PBW Project No. 5196A

**PROFESSIONAL CERTIFICATION**

This document and all attachments were prepared by Pastor, Behling & Wheeler, LLC under my direction or supervision in accordance with a system designed to assure that qualified personnel properly gather and evaluate the information submitted. Based on my inquiry of those persons directly responsible for gathering the information, the information submitted is, to the best of my knowledge and belief, true, accurate, and complete. I hereby certify that the conceptual closure plan was developed in accordance with the requirements of 40 CFR 257.102(b) of the CCR Rule.

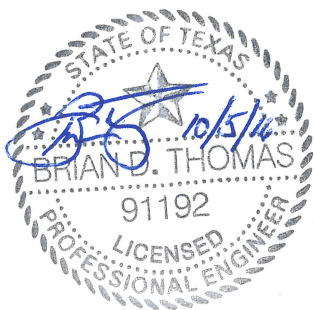

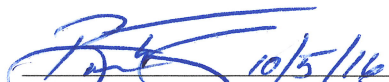
  
\_\_\_\_\_  
Brian Thomas, P.E.  
Principal Engineer  
PASTOR, BEHLING & WHEELER, LLC

LUMINANT

**TABLE OF CONTENTS**

	<u>Page</u>
PROFESSIONAL CERTIFICATION .....	i
LIST OF FIGURES .....	iii
LIST OF APPENDICES .....	iii
1.0 INTRODUCTION .....	1
1.1 CCR Surface Impoundment Closure Plan Requirements .....	1
1.2 MOSES Impoundments Subject to CCR Closure Plan Requirements.....	3
1.3 Description of Bottom Ash Ponds .....	4
2.0 CLOSURE PLAN FOR BOTTOM ASH PONDS .....	6
2.1 Description of CCR Impoundment Closure.....	6
2.2 Closure by Removal of CCR – Southwest Pond.....	6
2.3 Removal of Free Liquids and CCR Stabilization - BAPs .....	7
2.4 Final Cover Systems – Northeast and West Ponds .....	8
2.4.1 Compacted Clay Cap .....	8
2.4.2 Geosynthetic Cap .....	9
2.5 Final Cover System Slope Stability .....	9
2.6 Stormwater Run-off Control .....	9
2.7 CCR Inventory and Area to Be Capped.....	10
2.8 Closure Schedule .....	10
3.0 REFERENCES .....	11

LUMINANT

## **LIST OF FIGURES**

<u>Figure</u>	<u>Title</u>
1	Site Location Map
2	Site Vicinity Map
3	Existing Site Plan
4	Proposed Grading Plan – CCR Unit Final Cover
5	Surface Water Control Plan
6	Typical Construction Details – CCR Cover System
7	Typical Drainage Control Details

## **LIST OF APPENDICES**

<u>Appendix</u>	<u>Title</u>
A	Technical Specifications
B	Hydrologic Evaluation of Landfill Performance (HELP) Model Output
C	SLIDE 7.0 – Cap/Cover System Slope Stability Model Output
D	Stormwater Hydrology Calculations
E	Project Schedule – CCR Closure Process

## 1.0 INTRODUCTION

Luminant Generation Company LLC (Luminant) owns and operates the Monticello Steam Electric Station (MOSES) located off FM 127 approximately nine miles southwest of Mount Pleasant, Texas (Figure 1). The power plant and related support areas occupy approximately 1,000 acres on a peninsula located between Lake Monticello and Lake Bob Sandlin (Figure 2). The MOSES consists of three coal/lignite-fired units with a combined operating capacity of approximately 1,880 megawatts. Coal Combustion Residuals (CCR) including fly ash, bottom ash, flue gas desulfurization materials, and boiler slag are generated as part of MOSES unit operation. The CCRs are transported off-site for beneficial use by third-parties or are placed in mine pits in the Winfield South Mine/G-Ash Area.

The CCR Rule (40 CFR 257 Subpart D - *Standards for the Receipt of Coal Combustion Residuals in Landfills and Surface Impoundments*) has been promulgated by EPA to regulate the management and disposal of CCRs as solid waste under Resource Conservation and Recovery Act (RCRA) Subtitle D. The final CCR Rule was published in the Federal Register on April 17, 2015. The effective date of the CCR Rule was October 14, 2015.

The CCR Rule establishes national operating criteria for existing CCR surface impoundments and landfills, including development of closure plans for all CCR impoundments and landfills. Pastor, Behling & Wheeler, LLC (PBW) was retained by Luminant to develop this closure plan for the CCR impoundments at the MOSES.

### 1.1 CCR Surface Impoundment Closure Plan Requirements

40 CFR 257.102(b) of the CCR Rule specifies that a written closure plan must be prepared for each existing CCR surface impoundment that describes the steps necessary to close the impoundment at any point during the active life of the unit consistent with recognized and generally accepted good engineering practices. The closure plan must include, at a minimum, the following information:

- A narrative description of how the CCR impoundment will be closed in accordance with 40 CFR 257.102;
- If closure of the impoundment will be accomplished through removal of CCR from the unit, a description of the procedures to remove the CCR and decontaminate the impoundment in accordance with 40 CFR 257.102(c) of the CCR Rule. CCR removal and decontamination of the impoundment are considered complete when constituent concentrations throughout the impoundment and any areas affected by releases from the unit have been removed and groundwater monitoring concentrations do not exceed applicable groundwater protection standards.

- If closure of the impoundment will be accomplished by leaving CCR in place, the closure plan will provide a description of the final cover system designed in accordance with 40 CFR 257.102(d) of the CCR Rule, including details concerning the methods and procedures used to install the final cover. The closure plan must also discuss how the final cover system will achieve the following performance standards specified in 40 CFR 257.102(d):
  - Control, minimize or eliminate, to the maximum extent feasible, post-closure infiltration of liquids into the waste and releases of CCR, leachate, or contaminated run-off to the ground or surface waters or to the atmosphere;
  - Preclude the probability of future impoundment of water, sediment, or slurry;
  - Include measures that provide for major slope stability to prevent the sloughing or movement of the final cover system during the closure and post-closure care period;
  - Minimize the need for further maintenance of the unit; and
  - Be completed in the shortest amount of time consistent with recognized and generally accepted good engineering practices.

Prior to installing the final cover system on the closed impoundment, free liquids must be eliminated by removing liquid wastes or solidifying the remaining wastes and waste residues and the remaining wastes must be stabilized sufficiently to support the final cover system.

The final cover system must be designed and constructed to meet the following criteria:

- The permeability of the final cover system must be less than or equal to the permeability of any bottom liner system or natural subsoils present, or a permeability no greater than  $1 \times 10^{-5}$  cm/sec, whichever is less.
- The infiltration of liquids through the closed CCR unit must be minimized by the use of an infiltration layer that contains a minimum of 18 inches of earthen material.
- The erosion of the final cover system must be minimized by the use of an erosion layer that contains a minimum of six inches of earthen material that is capable of sustaining native plant growth.
- The disruption of the integrity of the final cover system must be minimized through a design that accommodates settling and subsidence.

An alternative final cover system design may also be used, provided the alternative final cover system is designed and constructed to meet the following criteria:

- The alternative final cover system must include an infiltration layer that achieves an equivalent reduction in infiltration as the infiltration layer specified above.
- The alternative final cover system must include an erosion layer that provides equivalent protection from wind or water erosion as the erosion layer specified above
- The disruption of the integrity of the alternative final cover system must be minimized through a design that accommodates settling and subsidence.

- An estimate of the maximum inventory of CCR ever on-site over the active life of the impoundment and an estimate of the largest area of the impoundment ever requiring a final cover at any time during the active life of the unit.
- A schedule for completing all activities necessary to satisfy the closure criteria, including an estimate of the year in which all closure activities for the impoundment will be completed. The schedule should provide sufficient information to describe the sequential steps that will be taken to close the unit, including identification of major milestones such as coordinating with and obtaining necessary approvals and permits from other agencies, the dewatering and stabilization phases of impoundment closure, or installation of the final cover system, and the estimated timeframes to complete each step or phase of unit closure.
- In accordance with 40 CFR 257.102(e)(1) of the CCR Rule, closure of a surface impoundment must be initiated no later than 30 days after the date on which the impoundment either receives the known final receipt of CCR or non-CCR waste or the known final volume of CCR is removed from the impoundment for the purpose of beneficial use. Alternatively, under 40 CFR 257.1032(e)(2), closure of the impoundment must be initiated if the impoundment has been idle and has not received CCR or non-CCR waste for two years. Additional two year extensions to initiate closure may be obtained with appropriate documentation.
- In accordance with 40 CFR 257.102(f) of the CCR Rule, closure of a surface impoundment must be completed within five years of commencing closure activities. Additional extensions to complete closure may be obtained with appropriate documentation.

The impoundment closure plan must be certified by a qualified professional engineer and must document how the closure plan has been designed and constructed to comply with the requirements of 40 CFR 257.102(b)(4) of the CCR Rule.

In accordance with 40 CFR 257.102(b)(2) of the CCR Rule, the initial written closure plan for an existing CCR surface impoundment must be completed and placed in the facility operating record no later than October 17, 2016.

## **1.2 MOSES Impoundments Subject to CCR Closure Plan Requirements**

The CCR Rule defines coal combustion residuals such as fly ash, bottom ash, boiler slag, flue gas desulfurization (FGD) materials (gypsum), and related solids generated from burning coal for the purpose of generating electricity by electric utilities and independent power producers. The closure plan requirements of the CCR Rule apply to surface impoundments that dispose or otherwise engage in solid waste management of CCRs. The surface impoundments at the MOSES that meet the definition of an existing CCR unit are the Northeast Ash Water Retention Pond (NE Pond), West Ash Settling Pond (West Pond) and the Southwest Ash Settling Pond (SW Pond); collectively referred to as the Bottom Ash Ponds (BAPs).

### 1.3 Description of Bottom Ash Ponds

The existing site plan for the MOSES BAPs is shown on Figure 3. The BAPs receive recovered overflow from bottom ash dewatering bins and other MOSES process wastewater sources. The ponds also act as a surge basin for various water streams in the ash-water system. Recovered sluice water, process waters and storm water runoff from the MOSES ash-water system are pumped to each pond through a series of above grade pipes on the east end. The BAPs are constructed partially above and partially below grade and all material that enters the ponds is pumped into the impoundments. There are no gravity discharges to the BAPs.

The Bottom Ash Ponds serve as settling basins to remove residual bottom ash and fines from recovered sluice water associated with the dewatering bins. Water is pumped from the SW Pond, as needed, and returned for reuse in the bottom ash system. When sufficient ash has accumulated in either the NE or West Ponds, the recovered sluice water is diverted to the other pond. Ash is then removed from the first pond and transported via train car to G Ash Area. Based on the design of the BAPs, minimal accumulation of solids occurs within the SW Pond.

The BAPs are surrounded by engineered earthen dikes that extend approximately 10 to 20 feet above grade depending on the surrounding topography. The exterior slopes of the embankments are vegetated with grasses and similar vegetation. The south embankment of the Northeast Pond and east embankment of the SW Pond also act as embankments for the MOSES Storm Water Collection Pond, which is not subject to the CCR rule.

The BAPs were originally constructed in 1974 as a two-basin system and were subsequently segregated and relined with a 3-foot thick clay liner in 1990. As-built engineering drawings indicate that the existing 3-foot compacted clay liner was constructed to a maximum permeability of  $1 \times 10^{-7}$  cm/sec (Burns and McDonnell, 2015).

The crest elevation of the earthen embankments is approximately 386.5 feet MSL and the design operating fluid/CCR level in the BAPs is approximately 384 feet MSL (approximately 2.5 feet below the crest of the perimeter embankments). Based on an operating elevation of 384 feet MSL, the design operating capacity of the NE Pond, West Pond, and SW Pond are 100, 130, and 145 acre-feet, respectively. The total design operating capacity of the BAPs is approximately 122,200,000 gallons or



approximately 375 acre-ft.

The BAPs are classified as a low hazard potential impoundment in accordance with the requirements of 40 CFR 257.73(a)(2) of the CCR Rule (PBW, 2016).

LUMINANT

## 2.0 CLOSURE PLAN FOR BOTTOM ASH PONDS

Although the closure plan presented herein for the BAPs was developed in accordance with the requirements of 40 CFR 257.102 of the CCR Rule, this plan should be considered conceptual in nature given the fundamental assumptions used as the basis of the closure plan. Upon initiation of final CCR unit closure activities, the conceptual closure plan should be reviewed and revised to ensure appropriate modifications are incorporated into the final design plans and specifications prior to release for bidding and construction.

### 2.1 Description of CCR Impoundment Closure

With exception of the SW Pond, Luminant plans to close both the NE Pond and West Pond in accordance with 40 CFR 257.102(d) of the CCR Rule by leaving CCR in-place and constructing a final cover system over CCR located within the combined footprint of these two surface impoundments. For the purposes of this conceptual closure plan, PBW has assumed the SW pond will be closed by removing CCR solids from the unit, as a limited volume of CCR has accumulated within the impoundment. CCR and associated decontamination spoil material will be placed within the limits of the proposed cap and cover system for the remaining BAPs. However, if the total volume of CCR solids in the SW Pond at the time of closure are greater than 10 percent of the total impoundment capacity Luminant may consider closing the CCR unit in place. Additional details concerning decontamination and closure of the SW Pond are described in Section 2.2.

### 2.2 Closure by Removal of CCR – Southwest Pond

Pending a more detailed evaluation of the actual volume of CCR solids following the dewatering of the SW Pond, closure will be achieved by removal of CCR and areas potentially affected by the storage of CCR within the Surface Impoundment. The CCR removal action will generally consists of the following actions:

- Free liquids will be removed from the SW Pond to allow for verification of the actual depth of CCRs remaining in the surface impoundment. Recovered fluids will be characterized and managed in accordance with applicable regulatory requirements. The observed CCR thickness data will be used to estimate the volume of CCR prior to initiating closure of the unit via removal of CCR. As previously mentioned, the presence of a total volume of CCR solids exceeding 10 percent of the total impoundment capacity of the SW Pond at the time closure is initiated will trigger a re-evaluation of the proposed closure of the unit via CCR removal. The proposed grading plan for the SW Pond requires a substantial volume of fill; hence, incorporation of a suitable cover system over the limits of CCR within the unit is practicable using the proposed grading plan.

- After the free liquids are removed, CCR solids will be excavated from the impoundment. In accordance with 40 CFR 257.102(c), a minimum of 6-inches of the interior embankment and bottom clay liner will also be removed along with the CCR solids. The interior embankment will be visually inspected to ensure all CCR has been removed.
- CCR solids and excavated spoil material from the interior embankment of the SW Pond will be removed and transported to the NE or West Ponds for use as bridging fill as part of closure of these impoundments.
- After removal of the 6-inches of clay liner from the interior embankments and bottom of the SW Pond a grid-based confirmation sampling plan will be developed and implemented to characterize concentrations of CCR indicator constituents listed in Appendix IV of the CCR rule. A sufficient number of samples will be collected (minimum of 12) to allow for statistical evaluation of the characterization data to ensure areas potentially affected by releases from the CCR unit are removed.
- Upon review and verification that the CCR unit has been adequately decontaminated, the southwestern portion of the embankment will be breached and the embankment materials and imported fill will be used to fill the former SW Pond. Fill material will be placed to an elevation that provides drainage relief from the interior of the former pond to the southwest towards Lake Monticello via an existing surface water drainage ditch. Interior surface grading will provide a minimum of 0.5 percent drainage relief within the footprint of the former impoundment to ensure (to the maximum extent feasible) that ponding is minimized and that post-closure run-off is conveyed off the former impoundment area. The grading plan within the limits of the SW Pond will be increased to three percent and the cover system specified in Section 2.4 will be included in a revised closure plan if the total volume of CCR solids exceeds 10 percent of the total impoundment capacity of the SW Pond at the time closure is initiated.

### **2.3 Removal of Free Liquids and CCR Stabilization - BAPs**

Free liquids present within the NE and West Ponds will be removed by constructing dewatering sumps within accessible areas of the CCR prior to the placement of cap subgrade and the final cover system.

Free liquids removed from the impoundments will be managed in accordance with applicable state regulations. Following the removal of liquids from the impoundments, the stability of the CCR material should be evaluated to ensure adequate bearing capacity for equipment used to construct the cap. For the purposes of this conceptual closure plan, PBW has assumed that the dewatered CCR will accommodate construction equipment necessary to place a minimum two-foot thick bridging lift of approved fill. To the extent practicable prior to and during placement of the bridging lift, CCR within the impoundments will be progressively graded to achieve a uniform slope (+/- 1%) across the impoundments. The bridging lift will be placed to establish a suitable base for placement of the cap subgrade, and will consist of an initial one-foot thick compacted lift followed by two six-inch compacted lifts. Approved materials for use in the bridging lift and placement methods will conform to the Technical Specifications for general earthwork and CCR stabilization provided in Sections 02300 and 02310, respectively (Appendix A).

## 2.4 Final Cover Systems – Northeast and West Ponds

For the purposes of this conceptual closure plan, two final cover system options for the BAPs are presented in this section. In accordance with 40 CFR 257.102(d) of the CCR Rule, the permeability of each final cover system option will be less than or equal to the permeability of the existing bottom liner in the BAPs (i.e. 3 foot clay liner with a permeability of  $<1 \times 10^{-7}$  cm/sec). The proposed final grading plan for the final cover system is illustrated in Figure 4, and typical construction details and surface water drainage controls for each the final cover systems are provided in Figures 5-7.

Technical Specifications for material selection and placement of the proposed final cover system alternatives and the associated cap subgrade have been developed to minimize potential for differential settlement and subsidence. Post-closure monitoring activities will be performed to ensure the cover system complies with the requirements of the CCR Rule. Furthermore, an evaluation of infiltration through the proposed cover systems was developed using the U.S. Army Corps of Engineers – Hydrologic Evaluation of Landfill Performance (HELP) model (Appendix B). As demonstrated by the HELP model results, the permeability of the clay cap (infiltration layer) final cover system option will be less than or equal to the permeability of the bottom liner system and the permeability of the linear low density polyethylene cap option will achieve an improved reduction in infiltration compared to the clay cap (infiltration layer) option. Both final cover options will be designed to minimize impounding of water on the cap and associated long-term care activities.

### 2.4.1 Compacted Clay Cap

Select fill and/or CCR deemed suitable for beneficial use will be placed within the proposed limits of the impoundment cover system for the NE and West Ponds to the lines and grades specified for the cap subgrade (Figures 4 and 6). Upon placement of cap subgrade to within approximately five feet of proposed finished grade, only approved select fill material (i.e. embankment spoil material or contractor-supplied select fill) will be placed in accordance with the specifications for cap subgrade. A three foot thick compacted clay liner with permeability of no greater than  $1 \times 10^{-7}$  cm/sec will be placed on the prepared cap subgrade material. Cap subgrade and clay cap material selection, placement, compaction and testing will conform to the Technical Specifications in Section 02320 and 02330, respectively (Appendix A). An 18-inch minimum thickness vegetative soil layer will be placed in a single loose lift over the prepared clay cap and permanent vegetative cover will be established in accordance with Sections 02340 and 02350 of the Technical Specification (Appendix A).

### **2.4.2 Geosynthetic Cap**

Select fill and/or CCR deemed suitable for beneficial use will be placed within the proposed limits of the impoundment cover system for the BAPs to the lines and grades specified for the cap subgrade (Figures 4 and 6). Upon placement of cap subgrade to within approximately 2.5 feet of proposed finished grade, only approved select fill material (i.e. embankment spoil material or contractor-supplied select fill) will be placed in accordance with the specifications for cap subgrade. A 40-mil linear low-density polyethylene (LLDPE) liner will be installed over the prepared cap subgrade. LLDPE liner deployment, field seaming, and field quality assurance testing will conform to Section 02420 of the Technical Specifications (Appendix A). A geonet drainage layer will be installed above the LLDPE liner to provide lateral drainage relief of infiltration from the overlying vegetative soil layer. An 18-inch (minimum thickness) vegetative soil layer will be placed in a single loose lift over the prepared geosynthetic cap system and permanent vegetative cover will be established in accordance with Sections 02340 and 02350 of the Technical Specification (Appendix A).

### **2.5 Final Cover System Slope Stability**

Selection of suitable construction materials, proper material placement, and quality assurance testing of both the subgrade preparation and cover system installation in accordance with the Technical Specifications (Appendix A) will ensure stability of the final cover system. In addition, SLIDE 7.0 software simulations of slope stability were prepared to demonstrate that the proposed cover system is stable at the slopes specified in the conceptual closure plan (Appendix C). Previous slope stability modeling performed by Golder and Associates (O'Brien & Gere, 2015) concluded that the existing embankments are stable under both short-term and long-term modeling conditions. Updated slope stability modeling of the existing BAP embankments is currently being prepared by others to comply with initial and periodic stability evaluations required by 40 CFR 257.73(f) of the CCR Rule.

### **2.6 Stormwater Run-off Control**

The final grading of the BAPs cover system will establish uniform slopes of approximately 3 to 5 percent on the portion of the cap overlying CCR, and slope lengths will generally not exceed 300 feet. Surface drainage of the portion of the cap covering CCR will generally consist of sheet flow or shallow concentrated flow along diversion berms and/or within perimeter grass-lined channels (located outside the capped area) that will convey run-off to reinforced stormwater let-down structures. Both cover system alternatives will allow for lateral drainage of infiltration off the capped area to prevent saturation of the vegetative layer and/or ponding on the cover system. The geosynthetic cover system includes a drainage

layer above the impermeable capping system that is designed to collect infiltration from the vegetative layer and control discharge to the limits of the cover system, which also prevents saturation of the vegetative layer and/or ponding on the cover system. A conceptual run-off control plan that includes estimated peak discharges based on the 25-year/24-hour storm event (7.9 inches) for capped area is presented in Appendix D (Hershfield, 1961). Typical construction details for the geocomposite drainage layer, surface water conveyance structures are provided on Figure 6, and Technical Specifications for the geocomposite drainage layer and EnviroGrid™ slope erosion control are provided in Appendix A.

Re-evaluation of surface water drainage and necessary controls from the cover system of the West Pond and across the closed SW Pond will be necessary if closure via CCR removal is deemed impracticable.

## **2.7 CCR Inventory and Area to Be Capped**

For the purposes of this conceptual closure plan, in-place closure of CCR within the NE Pond and West Pond is based on the assumed volume of CCR (solids) contained in the ponds being limited to 50 percent of the capacity of the ponds. Based on this assumption, NE Pond and the West Pond will be closed as a single CCR management unit, which will contain approximately 172,300 cubic yards of CCR at time of closure. This estimated volume of CCR does not include CCR or decontamination spoil material relocated from the closure of the SW Pond or decontamination spoil material generated from the decontamination of the interior embankments of the NE Pond or the West Pond above the elevation of the aforementioned 50 percent solids capacity. A preliminary estimate of CCR solids and anticipated decontamination spoil material generated during closure of the SW Pond via removal of CCR is estimated at less than 40,000 cubic yards. The combined surface area of the NE Pond and the West Pond is approximately 12 acres. Given that the proposed limits of the cover system extends over the interior embankment between the ponds and extends beyond the historic limits of the CCR impoundments to tie-in with the exterior slope of the existing perimeter embankments, the final surface area of the cover system will exceed 16-acres. The final limits of the CCR cover system should be re-evaluated following closure of the SW Pond by removal of CCR to ensure the configuration of the cover system is optimized.

## **2.8 Closure Schedule**

The final closure of the BAPs will be completed within 5 years of start of closure; however, 40 CFR 257.102(f)(2) and 257.103 of the CCR Rule allow for extension of the closure schedule or demonstration that alternative closure requirements should apply to the CCR unit. A Gantt chart illustrating the sequential steps of the CCR closure process, including pre-construction activities (i.e. necessary notifications and permitting) as well as closure milestones, is included as Appendix E.

### 3.0 REFERENCES

Hershfield, OM. 1961. Rainfall Frequency Atlas of the United States for Durations from 30 minutes to 24 hours and Return Periods from 1 to 100 Years, U.S. Dept. Commerce, Weather Bureau. Technical Paper No. 40. Washington, DC.

O'Brien & Gere (OBG), 2014. *Dam Safety Assessment of CCW Impoundments, Monticello Steam Electric Station, Mount Pleasant, Texas*, EP-10W000673, June

Texas Commission on Environmental Quality (TCEQ), 2009. *Technical Guide No. 3 Nonhazardous Industrial Solid Waste Landfills*. June 12.

Texas Commission on Environmental Quality (TCEQ), 2004. *Technical Guide No. 4 Nonhazardous Industrial Solid Waste Surface Impoundments*. November 2.

U.S. Army Corps of Engineer, 1997, *Hydrologic Evaluation of Landfill Performance (Version 3.07)*, November 1.

LUMINANT

LUMINANT

**FIGURES**



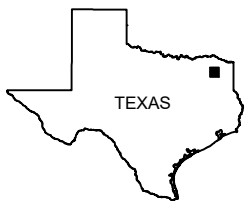
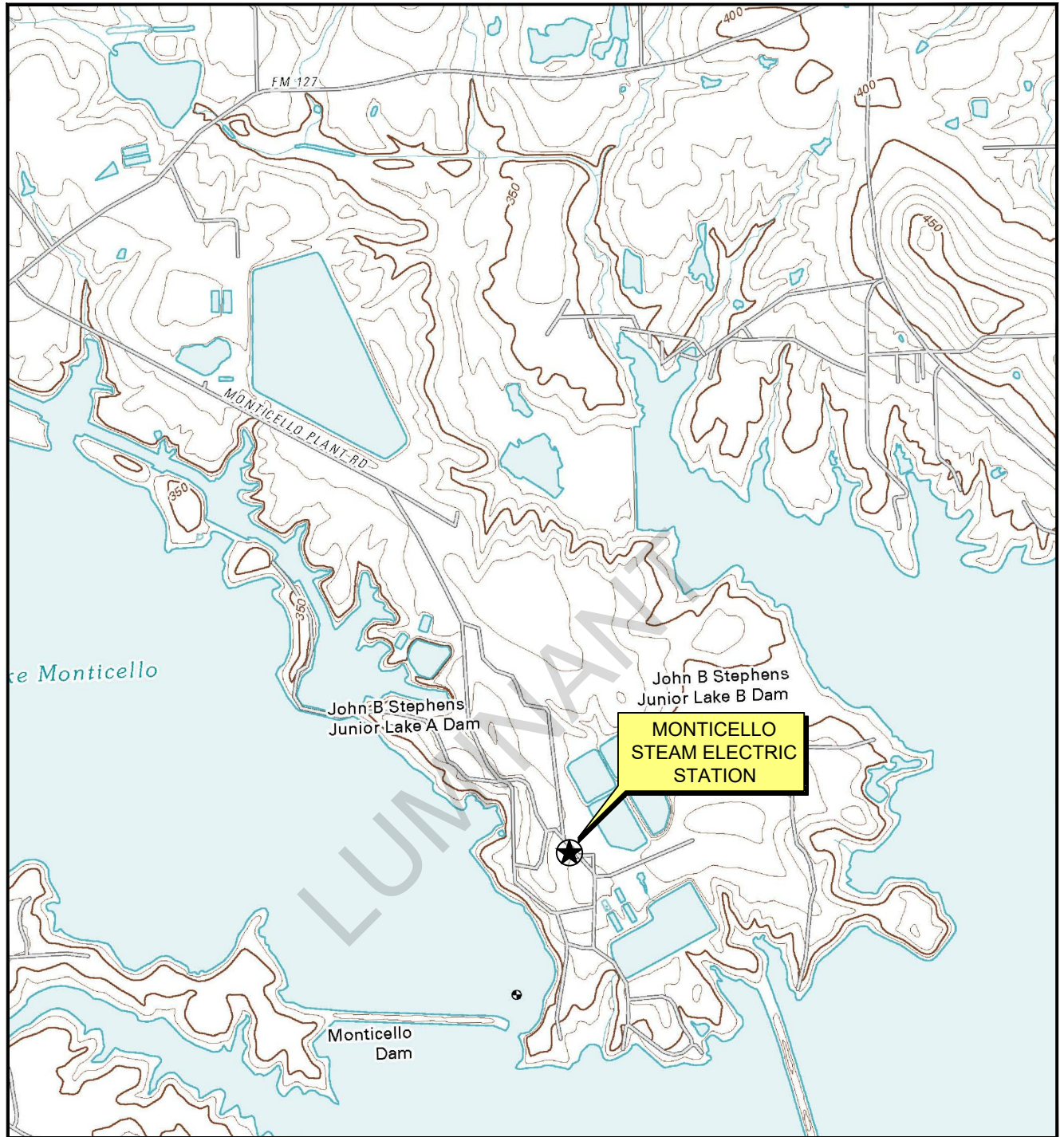

□ UADRANGLE LOCATIONS

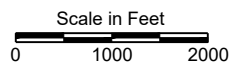

SOURCE:  
Base map from www.tnris.gov, Monticello, TX 7.5 min. USGS □uadrangle dated 2010.

**LUMINANT GENERATION COMPANY, LLC**  
MONTICELLO STEAM ELECTRIC STATION

Figure 1

**SITE LOCATION MAP**

PROJECT: 5196B

BY: AJD

REVISIONS

DATE: SEPT., 2016

CHECKED: BDT

**PASTOR, BEHLING & WHEELER, LLC**  
CONSULTING ENGINEERS AND SCIENTISTS

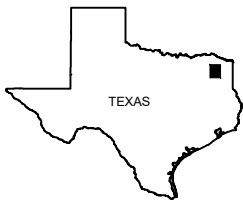

PHOTOGRAPH LOCATION



Scale in Feet

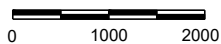

SOURCE:  
Imagery from Google Earth, aerial photography dated 12-5-15.

**LUMINANT GENERATION COMPANY, LLC**  
MONTICELLO STEAM ELECTRIC STATION

Figure 2

**SITE VICINITY MAP**

PROJECT: 5196B

BY: AJD

REVISIONS

DATE: SEPT., 2016

CHECKED: BDT

**PASTOR, BEHLING & WHEELER, LLC**  
CONSULTING ENGINEERS AND SCIENTISTS

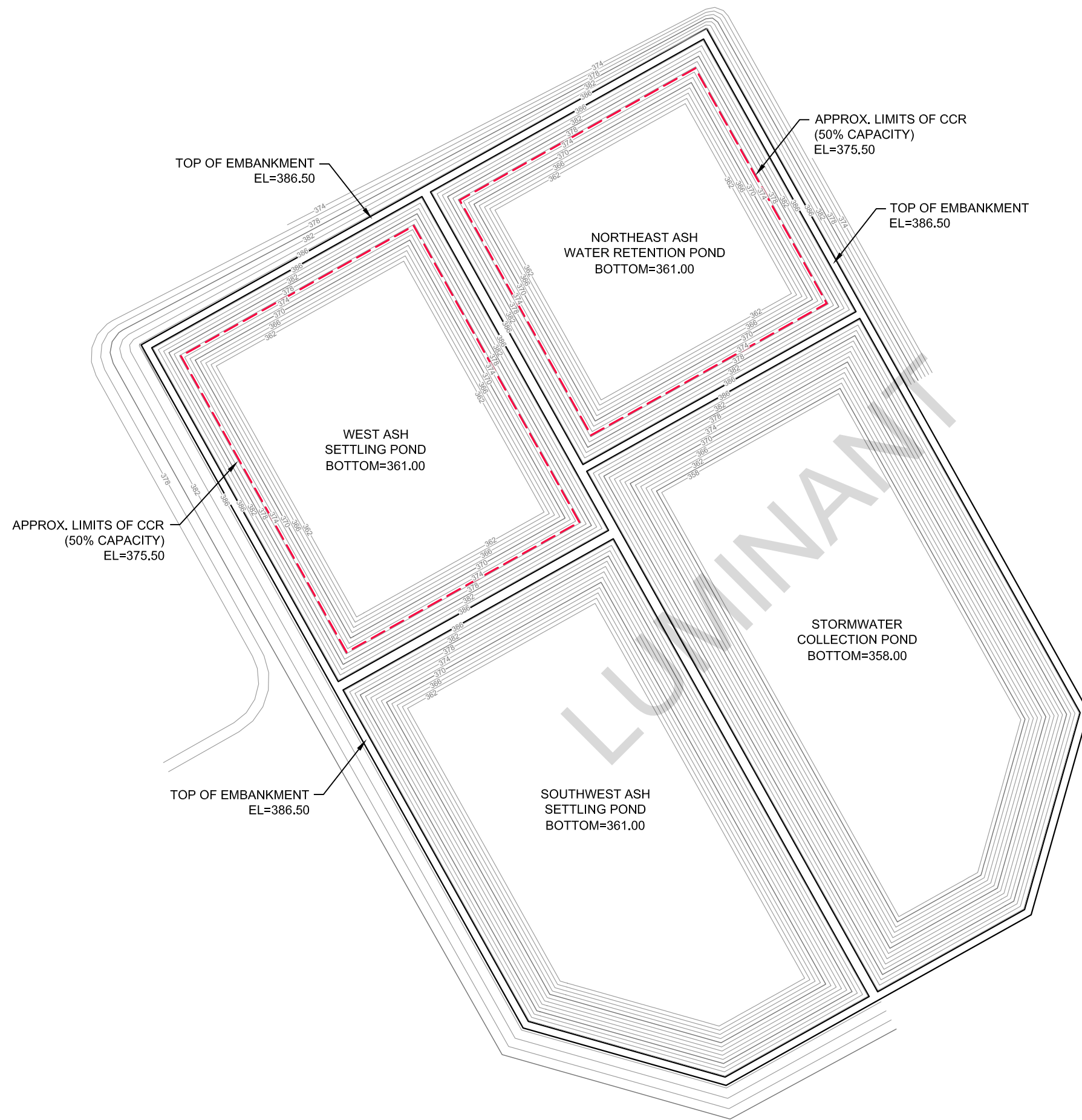

**EXPLANATION**

- Existing Grade Contour  
2 ft Interval
- Existing Grade Contour  
10 ft Interval
- - - 50 Percent Solid Fill Limit

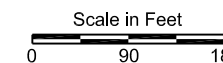

**LUMINANT GENERATION COMPANY, LLC**  
MONTICELLO STEAM ELECTRIC STATION

Figure 3

**EXISTING SITE PLAN**

PROJECT: 5196A	BY: AJD	REVISIONS
DATE: SEPT., 2016	CHECKED: BDT	

**PASTOR, BEHLING & WHEELER, LLC**  
CONSULTING ENGINEERS AND SCIENTISTS

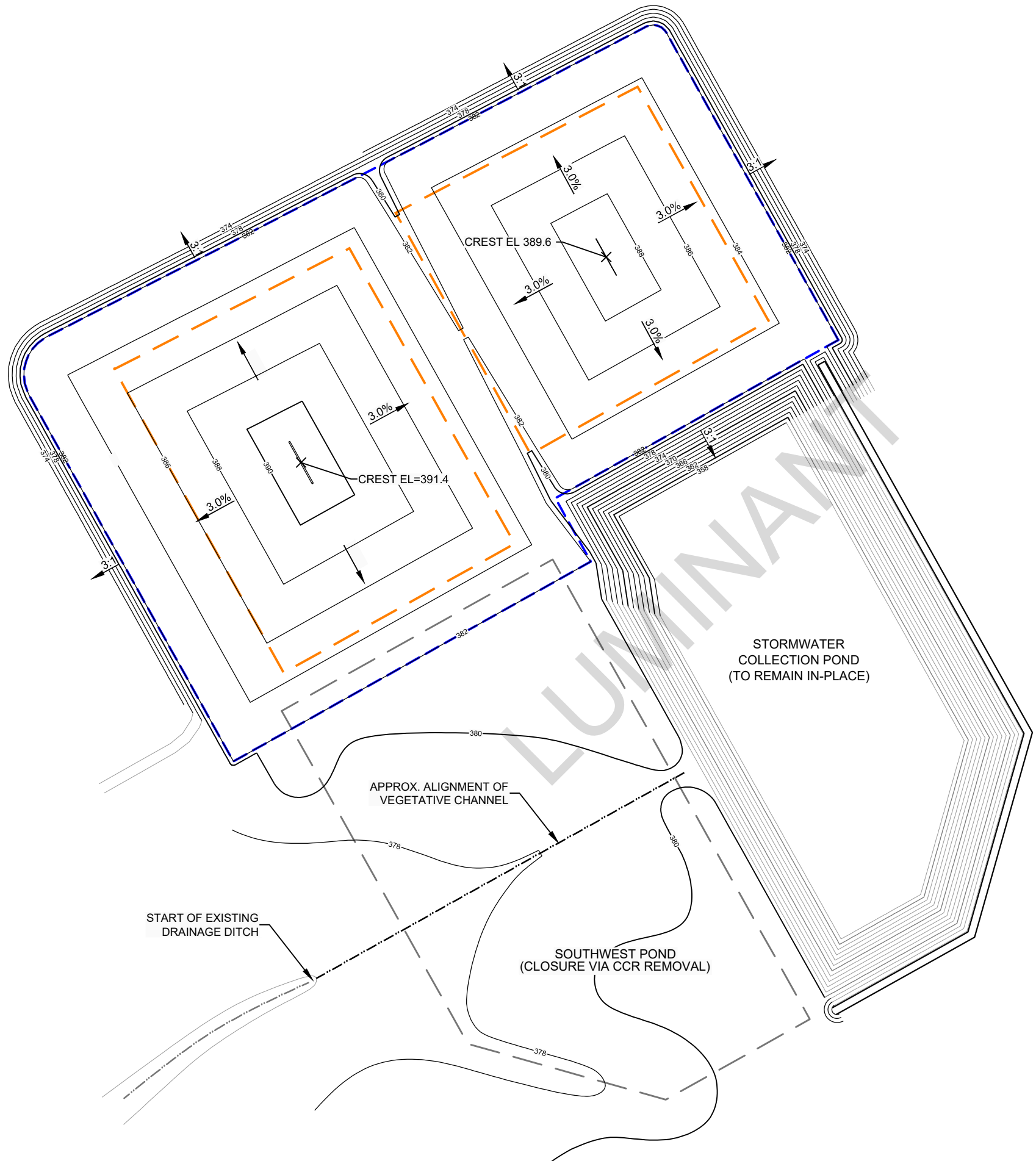

**EXPLANATION**

- Proposed Finished Grade Contour  
2 ft Interval
- Proposed Finished Grade Contour  
10 ft Interval
- Limits of CAP
- Estimated Limits of CCR  
(Elev. 375.5)

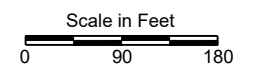

**LUMINANT GENERATION COMPANY, LLC**  
MONTICELLO STEAM ELECTRIC STATION

Figure 4

**PROPOSED GRADING PLAN-  
CCR UNIT FINAL COVER**

PROJECT: 5196A	BY: AJD	REVISIONS
DATE: SEPT., 2016	CHECKED: BDT	

**PASTOR, BEHLING & WHEELER, LLC**  
CONSULTING ENGINEERS AND SCIENTISTS

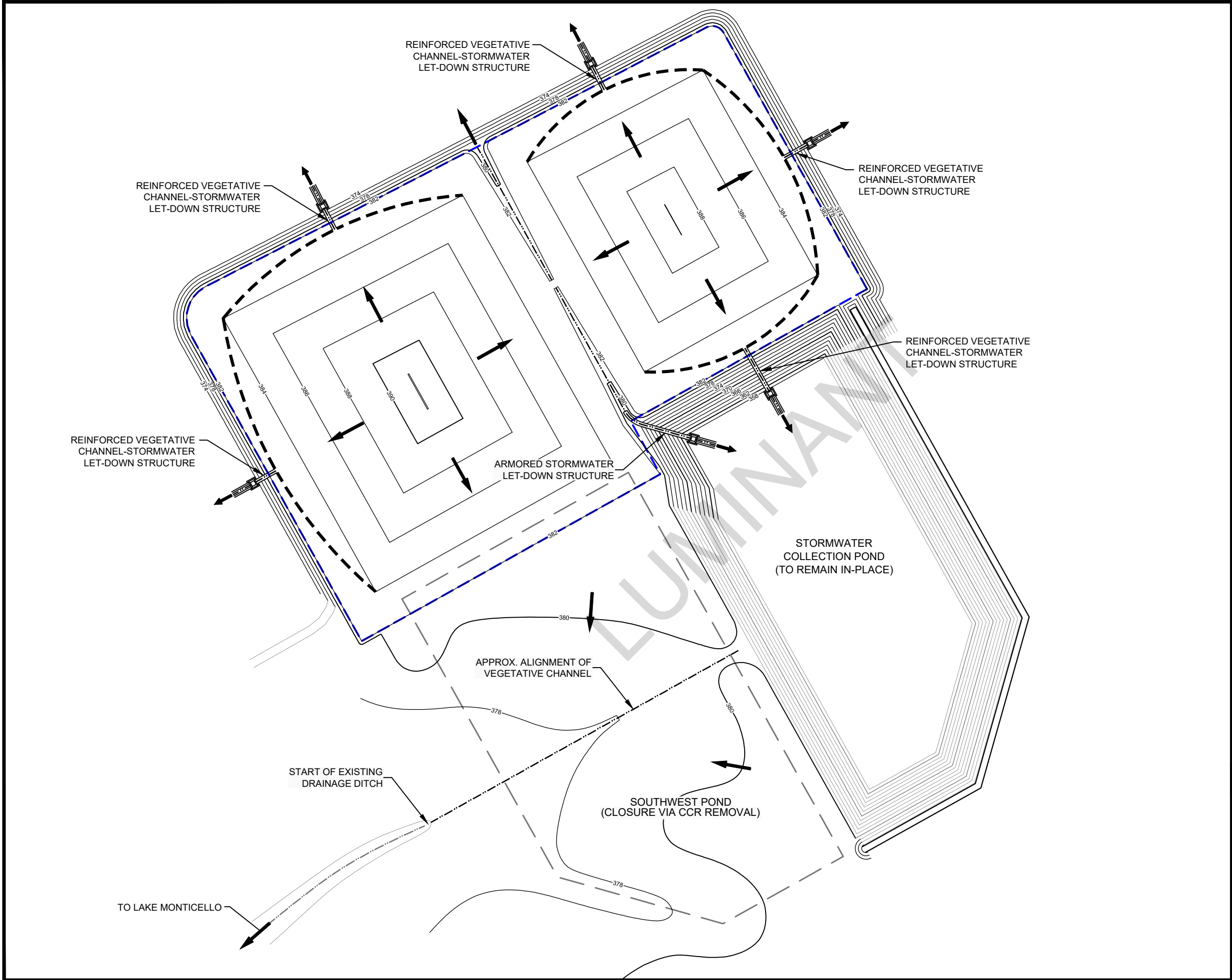

**EXPLANATION**

- Proposed Finished Grade Contour 2 ft Interval
- Proposed Finished Grade Contour 10 ft Interval
- - - Limits of CAP
- Sheet Flow
- · - · - Concentration Flow Path
- - - Approximate Alignment Stormwater Diversion Berm

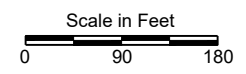

**LUMINANT GENERATION COMPANY, LLC**  
 MONTICELLO STEAM ELECTRIC STATION

Figure 5

**SURFACE WATER CONTROL PLAN**

PROJECT: 5196A	BY: AJD	REVISIONS
DATE: SEPT., 2016	CHECKED: BDT	

**PASTOR, BEHLING & WHEELER, LLC**  
 CONSULTING ENGINEERS AND SCIENTISTS

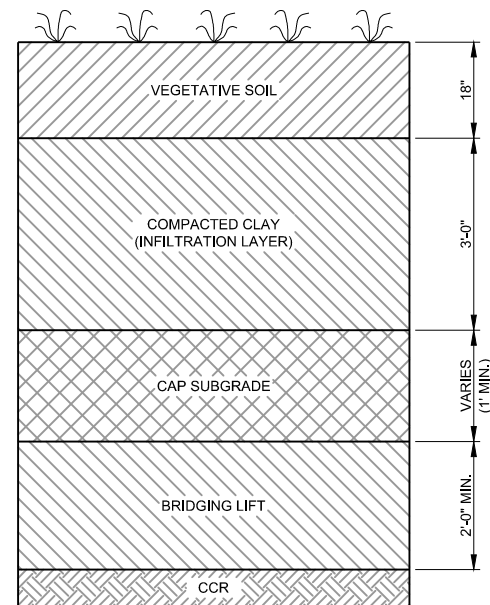

1  
7  
**CLAY CAP DETAIL**  
NOT TO SCALE

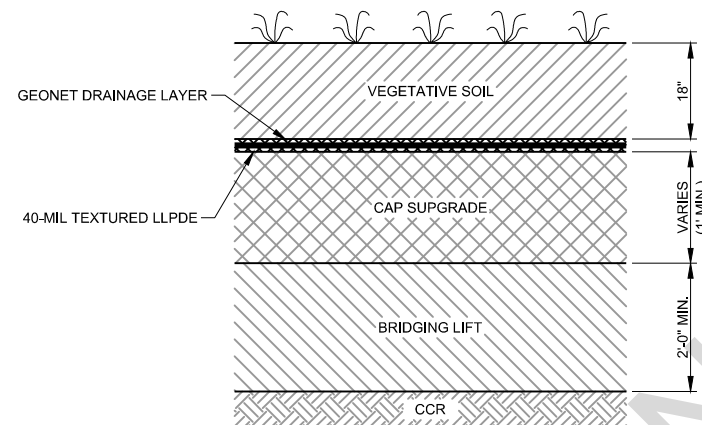

2  
7  
**GEOCOMPOSITE CAP DETAIL**  
NOT TO SCALE

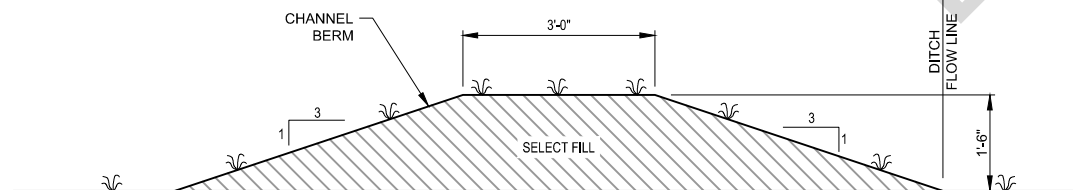

4  
7  
**CHANNEL BERM**  
NOT TO SCALE

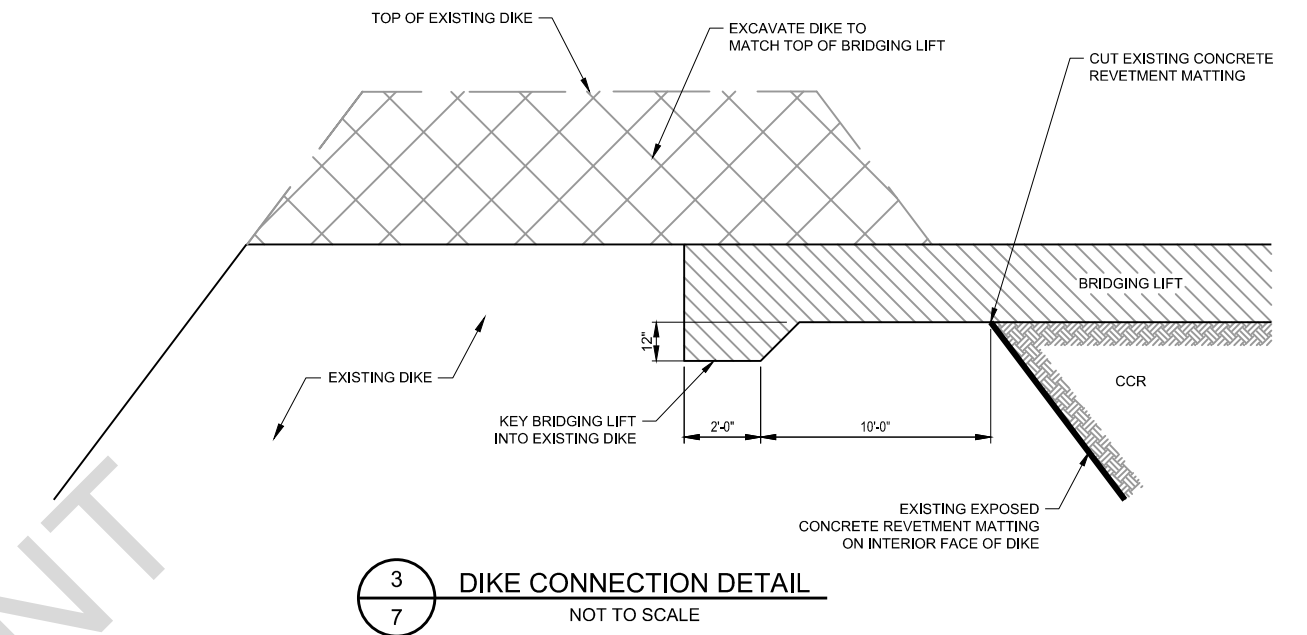

3  
7  
**DIKE CONNECTION DETAIL**  
NOT TO SCALE

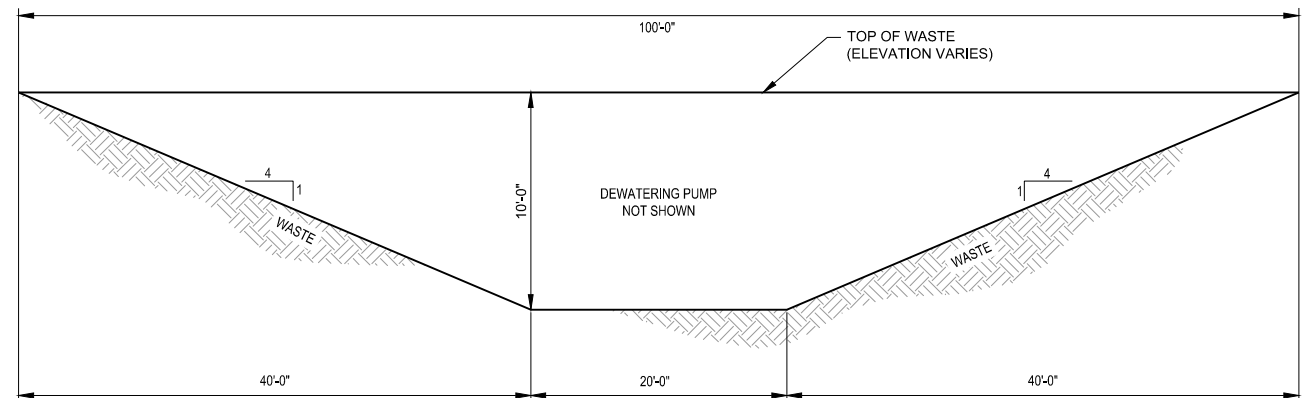

5  
7  
**DEWATERING SUMP DETAIL**  
NOT TO SCALE

**LUMINANT GENERATION COMPANY, LLC**  
MONTICELLO STEAM ELECTRIC STATION

Figure 6  
**TYPICAL CONSTRUCTION  
DETAILS - CCR COVER SYSTEM**

PROJECT: 5196A	BY: AJD	REVISIONS
DATE: SEPT., 2016	CHECKED: BDT	

**PASTOR, BEHLING & WHEELER, LLC**  
CONSULTING ENGINEERS AND SCIENTISTS

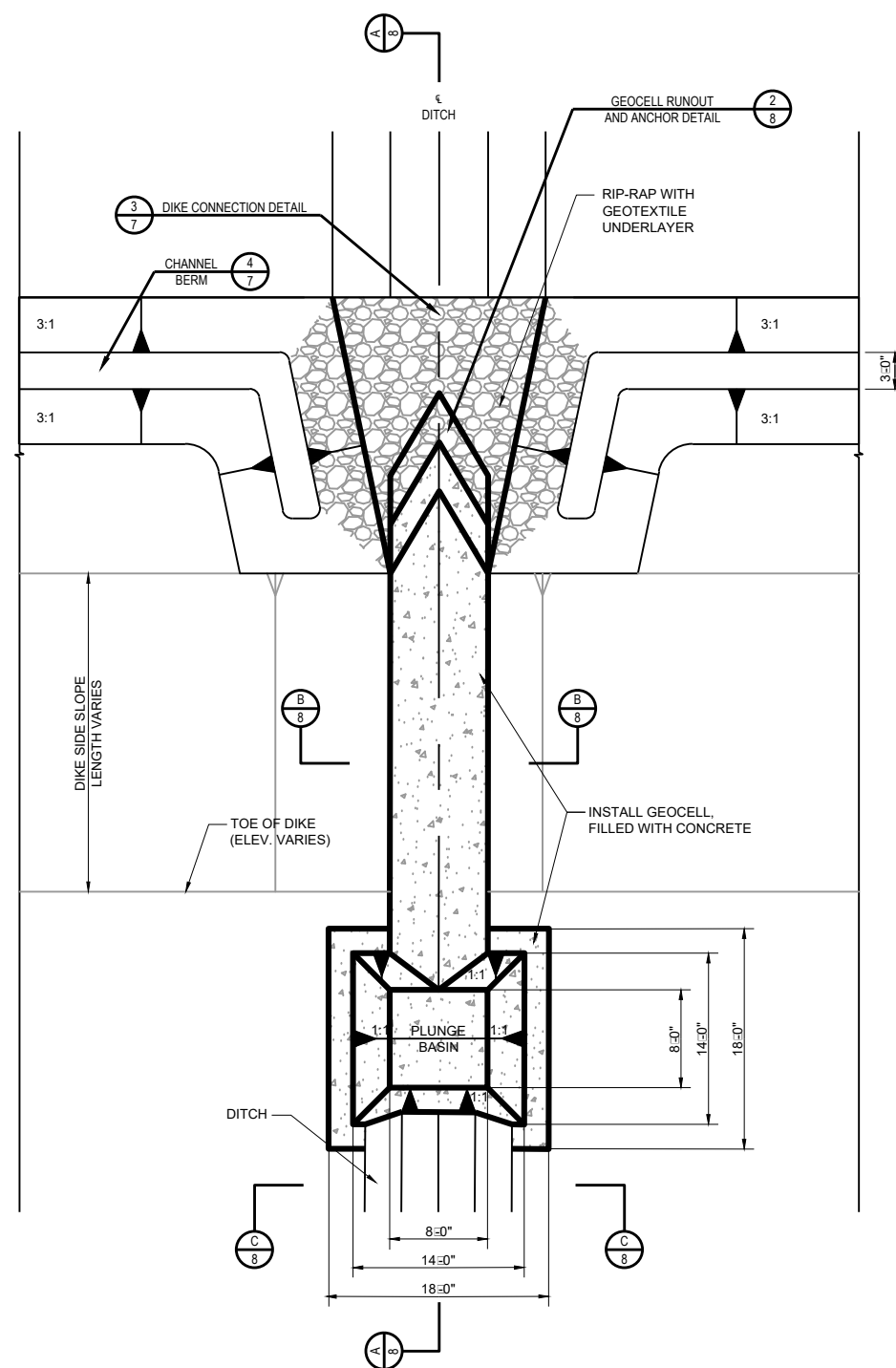

1/8 STORMWATER LET-DOWN STRUCTURE  
SCALE: 1"=20'

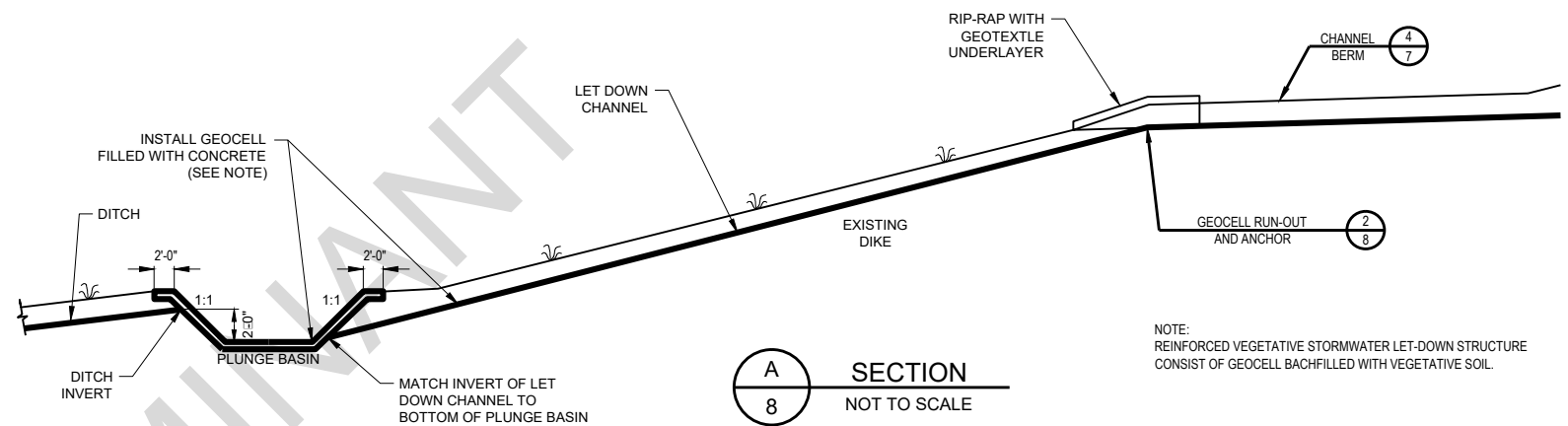
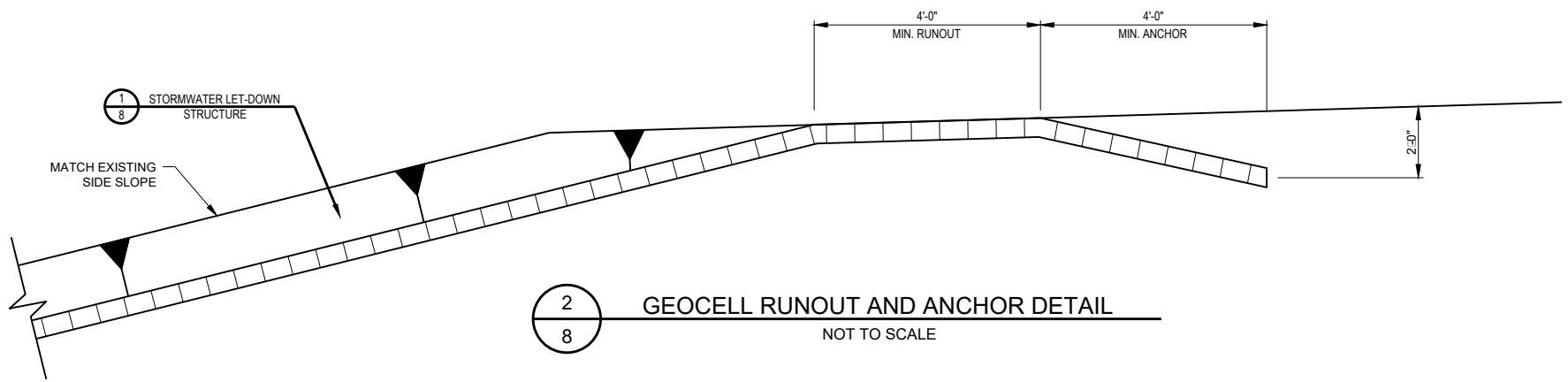

NOTE:  
REINFORCED VEGETATIVE STORMWATER LET-DOWN STRUCTURE  
CONSIST OF GEOCELL BACHFILLED WITH VEGETATIVE SOIL.

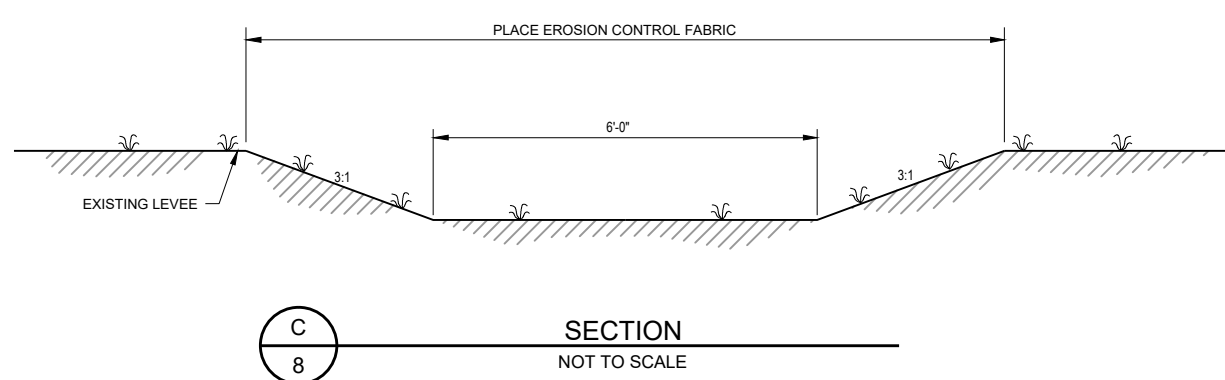
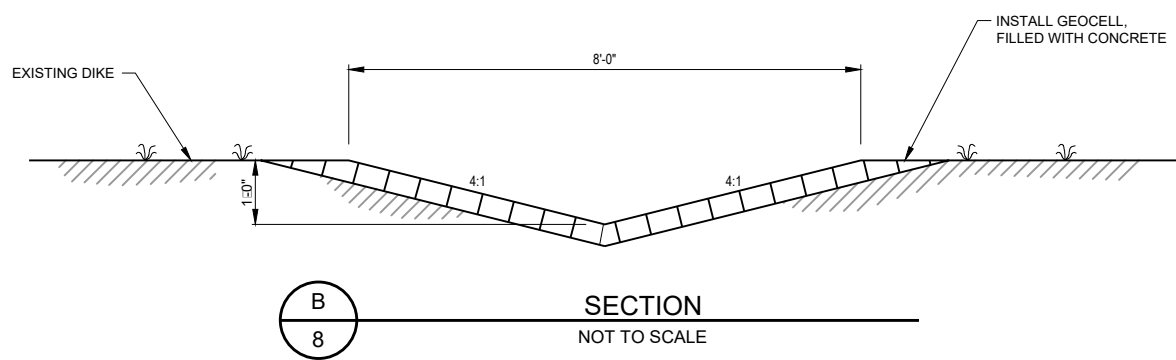

**LUMINANT GENERATION COMPANY, LLC**  
MONTICELLO STEAM ELECTRIC STATION

Figure 7  
**TYPICAL DRAINAGE CONTROL DETAILS**

PROJECT: 5196A	BY: AJD	REVISIONS
DATE: SEPT., 2016	CHECKED: BDT	

**PASTOR, BEHLING & WHEELER, LLC**  
CONSULTING ENGINEERS AND SCIENTISTS

**APPENDIX A**  
**TECHNICAL SPECIFICATIONS**

LUMIVANT



**BOTTOM ASH PONDS  
TECHNICAL SPECIFICATIONS**

LUMINANT

**MOSES BOTTOM ASH PONDS  
TECHNICAL SPECIFICATIONS  
TABLE OF CONTENTS**

Division 1 – General Requirements

Section 01100 – Erosion and Sedimentation Control

Section 01200 – Dust Control

Division 2 – Sitework

Section 02200 – Site Preparation

Section 02300 – Earthwork

Section 02310 – CCR Stabilization

Section 02320 – Cap Subgrade

Section 02330 – Clay Cap

Section 02340 – Vegetative Soil Layer

Section 02350 – Vegetation

Section 02420 – Flexible Membrane Liner (FML)

Section 02430 – Geotextile

Section 02440 – Geocomposite Drainage Layer

Section 02450 – Geocells

LUMINANT

## SECTION 01100

### EROSION AND SEDIMENTATION CONTROL

#### PART 1 - GENERAL

##### 1.1 DESCRIPTION

- A. This Section consists of furnishing, placing, and maintaining erosion and sedimentation control measures as shown on the Drawings, as directed by the COMPANY, and where necessary to reduce sediment content of runoff prior to establishment of permanent vegetation.

##### 1.2 PERFORMANCE REQUIREMENTS

- A. CONTRACTOR shall provide erosion and sedimentation control measures to control erosion and sediment runoff in any location where erosion and sediment runoff is likely to occur and as required by the COMPANY. Erosion and sedimentation control measures shall remain in place until removal is approved by the COMPANY.
- B. Clearing and stripping of vegetation, regrading and other construction activities shall be conducted in a manner to minimize erosion. Existing drainage patterns and vegetation shall be protected and retained to the greatest extent practicable.
- C. The size and duration of exposure of disturbed areas shall be kept to a minimum and all disturbed soil shall be stabilized as quickly as practicable. Diversion channels/berms shall be located upstream from disturbed areas to minimize the amount of run-on to the disturbed areas.
- D. In the event that erosion and sedimentation control measures used by CONTRACTOR prove to be inadequate as determined by COMPANY, CONTRACTOR shall be required to adjust his operations to the extent necessary to control sedimentation and shall repair areas impacted by sedimentation as directed by COMPANY at no additional cost to COMPANY.

##### 1.3 SUBMITTALS

- A. CONTRACTOR shall submit the following to COMPANY a minimum of 14 days prior to initiating field activities:
  - 1. A copy of the construction Storm Water Pollution Prevention Plan (SWPPP) developed for the Work.
  - 2. An installation schedule for erosion and sedimentation control measures. This schedule shall cover all ground disturbance activities including material staging areas and planned excavation and grading areas.
  - 3. Certification that all proposed erosion and sedimentation control products comply with the requirements of these specifications.

#### PART 2 - PRODUCTS

##### 2.1 SILT FENCE

- A. Silt fence fabric material shall be a woven geotextile conforming to the following requirements:

Physical Property	Test Method	Requirement
Tensile Strength, lb.	ASTM D4632	100 Minimum
Elongation @ Yield, %	ASTM D4632	10-40
Trapezoidal Tear, N (lb.)	ASTM D4533	50 Minimum
Apparent Opening Size	ASTM D4751	20-50
Permittivity, 1/sec	ASTM D4491	0.1 Minimum
UV Stability, 500 hr.	ASTM D4355	80 Minimum

- B. Posts shall be essentially straight wood or steel posts with a minimum length of 48 inches. Soft wood posts must be at least 3 in. in diameter or nominal 2 x 4 in. Hardwood posts must have a minimum cross-section of 1-1/2 x 1-1/2 inches. T- or L-shaped steel posts must have a minimum weight of 1.3 pounds per foot.

## 2.2 EROSION CONTROL FABRIC

- A. Erosion Control Fabric shall be North American Green S150 or COMPANY-approved equal.
- B. Erosion control fabric blanket shall have a minimum width of 6 feet. The fabric mat shall be machine-produced of 100 percent coconut fiber with colored line or thread along outer edges to indicate material overlap limits and shall have a minimum weight of 0.50lb./sq.yd.
- C. The top and bottom cover of the fabric shall be heavy-weight polypropylene netting with ultraviolet additives to delay breakdown. The mesh size shall be a minimum of 0.5 inch by 0.5 inch.
- D. The blanket and top/bottom covers shall be sown together on 1.5 inch center at 50 stitches per roll width with UV stable polypropylene thread.
- E. Erosion Control Fabric shall be installed using 6-in. wooden stakes or metal staples of sufficient material quality, cross-section, and strength to anchor the erosion control blanket against loads imposed by surface runoff and sediment.

## 2.3 HAY BALES

- A. Hay bales may be obtained from local sources and shall weigh 40 to 120 pounds per bale. Only grain hay bales, free of noxious weeds, shall be used. Bales shall be tightly and securely bound with wire to provide a stable bale and to extend the functional life of the bale to the extent practicable. Bales shall be free from rot and mold.
- B. Stakes for hay bales shall be wooden stakes or metal rebar of sufficient material quality, cross-section, and strength to secure the hay bales.

## 2.4 TEMPORARY VEGETATION

- A. Temporary Vegetation shall be applied on areas left exposed for greater than 30 days. CONTRACTOR shall use temporary vegetation seed mixture and application rate as specified in Section 02350, "Vegetation," or CONTRACTOR may alternatively submit proposed temporary vegetation seed mix and application rate to COMPANY for approval no later than 7 days prior to use.
- B. Mulch shall be applied after temporary vegetation seeding at a rate of 1.5 tons/acre for straw mulch, or at the rate recommended by the manufacturer if wood fiber mulch is used.

CONTRACTOR shall ensure that mulch does not redistribute after application. CONTRACTOR shall reapply mulch as necessary to maintain uniform coverage. Straw mulch shall include dry oat or wheat straw, native hay, or chopped corn stalks. The mulch shall be free from weeds and foreign matter detrimental to plant life. Wood fiber mulch shall include approved wood cellulose fiber in chip form and be free of ingredients that could inhibit germination and growth.

### **PART 3 - EXECUTION**

#### **3.1 GENERAL**

- A. Delivery, Storage, and Handling. Product delivery, storage and handling shall comply with manufacturer's recommendations. All erosion and sedimentation control products shall be delivered in manufacturer's wrapping and shall be stored in a manner to prevent damage. Damaged or unsuitable products shall be promptly removed from the job site and replaced with products meeting these specifications.
- B. All erosion and sedimentation control measures shall be installed in accordance with manufacturer's recommendations and approved by the COMPANY prior to initiating any clearing, demolition or construction activities.
- C. Cut Areas. Establish an erosion control line (hay bales or filter fabric) at toe of slope in all cut areas prior to beginning cut operations.
- D. Fill Areas. Establish an erosion control line (hay bales or filter fabric) approximately 10 feet from toe of slope of proposed fill areas prior to beginning fill operations.
- E. Stockpiles. Sides of soil stockpiles shall have a maximum slope of 2:1. All stockpiles shall be surrounded by a sediment barrier (hay bales or filter fabric) unless otherwise approved by the COMPANY. All stockpiles left bare for more than 30 days shall be stabilized with temporary vegetation and/or mulch.

#### **3.2 SILT FENCE**

- A. Silt fence shall be installed along the downstream perimeter of all disturbed areas to intercept sediment from sheet flow.
- B. Posts shall be embedded into the ground at least 18 inches deep and shall be spaced a maximum of 8 feet apart.
- C. Filter fabric shall be installed by digging a 6 inch wide by 6 inch deep trench along the upstream side of the fence. Place approximately 6 to 8 inches of the fabric in the trench and backfill the trench.
- D. Unless otherwise shown on the Drawings, attach the wire mesh to wooden posts with staples, or to steel posts with T-clips, in at least 4 places equally spaced. Sewn vertical pockets may be used to attach wire mesh or fabric to end posts.
- E. Fasten the fabric to the top strand of the reinforcement by rings or cord every 15 inches or less. Locate fabric splices at a fence post with a minimum overlap of 6 inches attached in at least 4 places equally spaced. Do not locate fabric splices in concentrated flow areas.

#### **3.3 EROSION CONTROL FABRIC**

- A. Erosion control fabric shall be installed following completion of final grading activities in the following disturbed earth areas unless otherwise approved by the COMPANY:
  - 1. All exterior slopes 4(H) to 1(V) and steeper; and
  - 2. All drainage ditches, channels and swales.

- B. Erosion control fabric shall be anchored at the top of the slope using an anchor trench and shall be rolled down the slope so as to maintain tension to preclude folds and wrinkles. Any folds or wrinkles shall be removed by hand.
- C. The erosion control fabric anchor trench shall be 6 inches wide by 6 inches deep. The trench fabric shall be connected to the vertical face of the trench using stakes or staples spaced at 12 inches on center. The trench shall be backfilled and compacted upon completion of stapling.
- D. Successive erosion control fabric panels shall be overlapped in such a manner that the upstream and upslope panel is placed over the downstream and downslope panel. Panels shall overlap a minimum of 6 inches at end joints and on sideslopes.
- E. Stake or staple through both panels with stakes/staples driven flush with the soil surface. Stake/staple spacing shall be in accordance with manufacturer's recommendations.

### **3.4 HAY BALES**

- A. Hay bales shall be installed to form water stops, filtration dams, diversions, etc. as required for erosion and sedimentation control. On sloping terrain, hay bales may be used to trap sediment until vegetation has become established.
- B. Place bales lengthwise with ends tight, abutting one another. Install bales with bindings located on the sides.
- C. Entrench hay bales a minimum of 4 inches and backfill. Place backfill on the upstream side of the bales.
- D. Secure the bale in place with two stakes per bale and insert straw in voids between bales.

### **3.5 MAINTENANCE**

- A. All erosion and sedimentation controls shall be maintained in a structurally sound and functional manner. All erosion and sedimentation controls shall be inspected at least on a weekly basis, immediately after each rainfall and daily during prolonged rainfall.
- B. Any damaged or deteriorating systems shall be replaced immediately upon discovery or as directed by COMPANY.
- C. Sediment deposits shall be removed when the deposit reaches 1/3 the height of the fence or sooner to provide a functional and stable system. Sediment retained by sedimentation and erosion control systems shall be removed by CONTRACTOR and may be used on the project as fill as approved by COMPANY.
- D. Areas where temporary vegetation or mulch has been applied shall be inspected to ensure proper growth and coverage. Temporary vegetation or mulch shall be reapplied as necessary to minimize erosion.

### **3.6 REMOVAL**

- A. Erosion and sedimentation controls shall remain in-place until the COMPANY directs their removal. Upon removal CONTRACTOR shall dispose of any sediment accumulations, dress the area to the satisfaction of COMPANY, and shall vegetate all bare areas in accordance with the Contract Documents. Temporary erosion control blanket materials specified are biodegradable and will remain in place after establishment of permanent vegetation.

++END OF SECTION++

## SECTION 01200

### DUST CONTROL

#### PART 1 - GENERAL

##### 1.1 DESCRIPTION

- A. This Section consists of performance of dust control measures as necessary to prevent fugitive dust during construction activities or as directed by the ENGINEER.

##### 1.2 PERFORMANCE REQUIREMENTS

- A. CONTRACTOR shall implement all necessary dust control measures to prevent fugitive dust during all construction activities.
- B. The need for dust control measures will be based on visual observation of airborne dust. CONTRACTOR shall implement dust control measures on a regular basis throughout the duration of the work unless otherwise authorized by the ENGINEER. CONTRACTOR shall adjust operations and/or dust controls as necessary, at no additional cost to OWNER, if directed by ENGINEER to mitigate dust.

##### 1.3 SUBMITTALS

- A. CONTRACTOR shall submit the following to ENGINEER a minimum of 5 days prior to initiating dust control measures:
1. Source of dust control water;
  2. List of dust control equipment; and
  3. Manufacturer specification sheets and material safety data sheets (MSDS) for chemical additives used for dust control.

#### PART 2 - PRODUCTS

##### 2.1 WATER

- A. Water used for dust control need not be potable, but must not be contaminated. Proposed source of dust control water must be approved by ENGINEER prior to initiating dust control measures.

##### 2.2 CHEMICAL ADDITIVES

- A. Chemical additives shall be incorporated into dust control measures only if approved by the ENGINEER.
- B. Calcium Chloride for dust control shall conform to the requirements of ASTM D98, Type 1 or Type 2.
- C. Alternative chemical additives for dust control may be used if approved by the ENGINEER.

##### 2.3 EQUIPMENT

- A. Dust control water shall be applied using tank trucks equipped with water cannon capable of delivering water through either front- or rear-mounted nozzles. Tank trucks shall be of sufficient size and mobility and carry a sufficient quantity of water to control dust generated by CONTRACTOR's activities.

- B. More than one water tank truck may be required during construction activities to sufficiently suppress dust.

### **PART 3 - EXECUTION**

#### **3.1 IMPLEMENTATION OF DUST CONTROL MEASURES**

- A. Vehicular traffic in disturbed areas shall be limited to the extent practicable. Construction vehicles shall maintain low speeds to minimize the amount of dust created. Adequate freeboard in loaded trucks shall be maintained to prevent spillage during operations. Roadway surfaces shall be kept free of spilled/tracked soil.
- B. Soil stockpiles shall be graded and shaped to minimize surface area. Water or covers shall be applied to stockpiles as needed to control dust.
- C. Apply dust control water uniformly over roads and disturbed areas from trucks capable of uniform distribution. Provide suitable devices for positive shut-off and for regulating flow of water.
- D. Apply calcium chloride or other chemical additives at locations only when directed by ENGINEER. Spread calcium chloride or other chemical additives by approved devices and methods for uniform distribution.
- E. Dust control water and/or chemical additives shall be applied so as to limit and/or prevent formation of standing water and mud; over spray of chemical dust suppressants in areas adjacent to surface water bodies or sensitive habitats; and/or flushing of materials off of the work area.

++END OF SECTION++



## SECTION 02200

### SITE PREPARATION

#### PART 1 - GENERAL

##### 1.1 DESCRIPTION

- A. This Section consists of all work associated with clearing and preparing the work area, borrow areas, and other work areas for earthwork and other construction activities, including removal of existing vegetation and verification of existing site conditions.

##### 1.2 EXISTING SITE CONDITIONS

- A. CONTRACTOR shall verify that existing topographic conditions in the Work Area as shown on the Drawings are an accurate representation of existing site conditions prior to initiating construction activities.
- B. If CONTRACTOR contends that existing topographic conditions are different from that shown on the Drawings, Contractor shall submit survey data from a Texas-registered land surveyor to document actual topographic conditions, and shall identify with such submission additional work required which was not accounted for in CONTRACTOR's bid. There shall be no opportunity for a Claim for extra work due to differing topographic conditions once stripping or excavation work has started.
- C. Existing site improvements (utilities, monitoring wells, and similar items) shall be located and protected by CONTRACTOR before CONTRACTOR begins clearing operations.

##### 1.3 SUBMITTALS

- A. Clearing and grubbing and solid waste generated during cap subgrade preparation shall be placed within the active portion of the landfill unless otherwise approved by the ENGINEER. CONTRACTOR shall submit name and address of the alternate disposal facility proposed for management of trash and rubbish generated in connection with site preparation at least 5 days prior to beginning clearing operations.

#### PART 2 - PRODUCTS

NOT USED

#### PART 3 - EXECUTION

##### 3.1 CLEARING

- A. Clearing shall consist of the cutting, shredding, and stockpiling of all trees and shrubs and the stripping of all grass and similar surface vegetation within the limits of the landfill and borrow areas. Clearing shall be limited to the areas required to perform the work.
- B. CONTRACTOR shall segregate material removed as part of clearing from soils to be incorporated into subsequent earthwork activities.

##### 3.2 VEGETATIVE SOIL STRIPPING AND STOCKPILING

- A. After completion of clearing activities, CONTRACTOR shall strip the uppermost approximately 12 inches of existing vegetative soil from the cleared areas. Material identified as vegetative soil shall be subject to ENGINEER's approval.

- B. CONTRACTOR shall stockpile stripped vegetative soil in the work area in a location acceptable to the ENGINEER.

### **3.3 DISPOSAL OF BRUSH AND OTHER VEGETATIVE MATERIAL**

- A. CONTRACTOR shall dispose of all brush and other vegetative materials generated during site clearing in accordance with all applicable regulations and as approved by the ENGINEER.
- B. If approved by the ENGINEER, CONTRACTOR may burn brush and other vegetative material in accordance with the requirements of TCEQ Publication RG-049 "Outdoor Burning in Texas", as modified to comply with OWNER requirements. Specific requirements for burning of brush and other vegetative material include, but are not limited to, the following:
  - 1. Commence or continue burning only when the wind direction and other weather conditions are such that the smoke and other pollutants will not present a hazard to any public road, landing strip, or water body or have an adverse effect on any off-site structure.
  - 2. Don't start burning unless weather conditions are such that the smoke will dissipate (winds of at least 6 miles per hour; no temperature inversions) while still allowing the fire to be contained and controlled (winds no faster than 23 miles per hour).
  - 3. Post someone to flag traffic if at any time the burning causes or may tend to cause smoke to blow onto or across a road or highway.
  - 4. Begin burning no earlier than one hour after sunrise, end it the same day and no later than one hour before sunset, and make sure that a responsible party is present while the burn is active and the fire is progressing.
  - 5. At the end of the burn, extinguish isolated residual fires or smoldering objects if the smoke they produce can be a nuisance or a traffic hazard.
- C. CONTRACTOR will be responsible for controlling fires in compliance with all Federal, State, and Local laws and regulations. The securing of necessary burning permits shall be the responsibility of the CONTRACTOR. All burning shall be under the constant care of competent watchmen. All materials resulting from clearing and grubbing operations and disposed of by burning on the site shall be thoroughly and completely reduced to ashes.
- D. CONTRACTOR shall be responsible for providing a suitable location (subject to ENGINEER and OWNER approval) for off-site disposal of cleared material not burned on-site. Once ENGINEER and OWNER have approved the disposal location, CONTRACTOR shall transport and dispose the material in accordance with all applicable regulations.

++END OF SECTION++

## SECTION 02300

### EARTHWORK

#### PART 1 - GENERAL

##### 1.1 DESCRIPTION

- A. This Section consists of all activities associated with earthwork construction, including, but not necessarily limited to:
1. Excavation, loading, transportation, unloading and stockpiling of soil from COMPANY-designated locations;
  2. Placement, compaction, and grading of various earthen materials;
  3. Ditch grading; and
  4. All other activities required to complete earthwork construction as shown on the Drawings, specified herein and or required by the COMPANY.

##### 1.2 REFERENCES

- A. American Society of Testing Materials (ASTM) Standards/Publications (Latest version):
- |       |   |
|-------|---|
| C33   | Standard Specification for Concrete Aggregates  |
| D422  | Method of Particle Size Analysis of Soils   |
| D698  | Laboratory Compaction Characteristics of Soil Using Standard Effort (12,400 ft-lbf/ft <sup>3</sup> )                            |
| D1557 | Laboratory Compaction Characteristics of Soil Using Modified Effort (56,000 ft-lbf/ft <sup>3</sup> )                            |
| D1587 | Standard Practice for Thin-walled Tube Sampling of Soils  |
| D2487 | Classification of Soils for Engineering Purposes  |
| D2922 | Density of Soil In Place by Nuclear Density Gage  |
| D3080 | Standard Test Method for Direct Shear Test of Soils Under Consolidated Drained Conditions                                       |
| D4318 | Liquid Limit, Plastic Limit and Plasticity Index of Soils   |
| D5084 | Standard Test Methods for Measurement of Hydraulic Conductivity of Saturated Porous Materials Using a Flexible Wall Permeameter |
| D6938 | Standard Test Method for In-Place Density and Water Content of Soil and Soil-Aggregate by Nuclear Methods (Shallow Depth)       |

##### 1.3 DEFINITIONS

- A. Select Fill: Soil material suitable for use as cap fill, for dike construction or other areas identified by the COMPANY.

- B. General Fill: Any non-classified soil deemed suitable by the COMPANY.
- C. Liner Subgrade: Soil complying with the specified requirements located immediately beneath the geosynthetic clay liner (GCL).
- D. Compacted Clay: Low-permeability soil layer of liner system.
- E. Vegetative Soil: Growth medium used along with any necessary admixtures to support vegetation.
- F. Gravel: Granular crushed stone material used as erosion protection in ditches.
- G. Road Base: Granular material placed on the surface of haul roads, access roads and other areas designated on the Drawings, identified in the Specifications or required by the COMPANY.
- H. Rip Rap: Stone armor material used in drainage features for erosion control and energy dissipation.

#### **1.4 SUBMITTALS**

- A. CONTRACTOR shall identify all earthwork material suppliers and shall submit written verification from his material suppliers that all earthwork materials to be used for the work comply with the requirements of this Section.
- B. CONTRACTOR shall submit copies of all geotechnical laboratory reports within 10 working days after sample collection.

#### **1.5 QUALITY CONTROL**

- A. CONTRACTOR shall perform construction surveys, as needed, to ensure that the lines and grades of all excavations, embankments, ditches, pipe trenches, pipe inverts, and graded surfaces are in accordance with the drawings and specifications.
- B. COMPANY may perform pre-construction and post-construction topographic surveys of the work area and related areas and may perform additional quality assurance surveys. CONTRACTOR shall coordinate his activities with COMPANY's surveyor and provide safe access to all excavation areas for survey and/or verification sampling activities.

#### **1.6 TESTING**

- A. The number and type of testing required for each type of earthwork shall be as specified in the specific section related to the type of earthwork.
- B. COMPANY will select the locations for all tests. Tests performed at locations not approved by the COMPANY will not be accepted.
- C. All undisturbed earthwork samples shall be collected using a thin-walled sampler complying with ASTM D1587. The length of the sampler shall be suitable for collection of an undisturbed sample over the specified sampling interval.
- D. Unless otherwise specified, testing shall be performed in accordance with the following methods:
  1. Soil classification shall be performed using ASTM D2487. Liquid Limits, Plastic Limits and Plasticity Indices shall be determined using ASTM D4318.
  2. Moisture-Density Relationships shall be determined using ASTM D698. Unless

otherwise directed by COMPANY. ASTM D1557 may be used only where specified.

3. In-place density and moisture content shall be determined using ASTM D6938 (Nuclear Density Gage). Other methods for determining in-place density and moisture may not be used unless approved by the COMPANY.
4. Hydraulic conductivity shall be determined using ASTM D5084.
5. Direct shear testing shall be performed in accordance with ASTM D3040.

## 1.7 TOLERANCES

A. Grades and slopes of all earthwork shall be straight and true. Unless otherwise specified, CONTRACTOR shall complete all earthwork within the dimensional tolerances presented below.

B. Elevation Tolerances:

1. Compacted Clay Surface: plus 0.1 foot, minus 0.0 foot.
2. Liner Subgrade Surface: plus 0.1 foot, minus 0.0 foot.
3. Gravel Surface: plus 0.1 foot, minus 0.0 foot.
4. All Other Surfaces: plus 0.2 foot, minus 0.0 foot.

C. Thickness Tolerances:

1. Compacted Clay Subgrade: plus 0.2 foot, minus 0.0 foot.
2. Liner Subgrade: plus 0.2 foot, minus 0.0 foot.
3. All Other Surfaces: plus 0.1 foot, minus 0.0 foot.

D. Grade Tolerances: All grades/slopes shall be completed within

1. Compacted Clay Surface: plus or minus 0.1 percent of design slope.
2. Liner Subgrade Surface: plus or minus 0.1 percent of design slope.
3. Gravel and Drainage Features: plus or minus 0.1 percent of design slope.
4. All Other Surfaces: plus or minus 0.2 percent of design slope.

E. Horizontal Coordinates and/or Earthwork Dimensions: plus or minus 0.5 feet

## 1.8 UTILITIES

A. COMPANY will attempt to deactivate electrical and other utilities in areas to be excavated; however, CONTRACTOR shall be ultimately responsible for ensuring that no energized equipment or utilities are present prior to initiating excavation activities. If CONTRACTOR identifies energized or active equipment or utilities, CONTRACTOR shall cease work and notify COMPANY so that the equipment/utilities may be deactivated. CONTRACTOR shall again check the equipment and utilities to ensure they are deactivated prior to proceeding with excavation activities.

B. CONTRACTOR shall note that underground and aboveground utilities may be located in the area of the Work. CONTRACTOR shall be ultimately responsible for protecting the utilities during earthwork and related activities.

## 1.9 EARTHWORK SAFETY

A. As discussed in other areas of these specifications, CONTRACTOR shall be fully responsible for the health and safety of all personnel in the work area, at all times, and shall take all necessary precautions to protect personnel.

- B. In addition to general health and safety responsibilities, CONTRACTOR shall be fully responsible for complying with all applicable OSHA and related regulations regarding earthwork, including, but not limited to, the requirements of 40 CFR Part 126.

**PART 2 - PRODUCTS**

**2.1 SELECT FILL**

- A. Select fill shall consist of soil excavated during foundation soil grading. CONTRACTOR shall be responsible for loading, transporting, placement and compaction of select fill.
- B. Select fill shall classify as CH, CL or SC using ASTM D2487, shall have a plasticity index between 15 and 40, and shall be free of roots, brush, sod, or other perishable materials and debris.

**2.2 GENERAL FILL**

- A. General fill shall be any non-classified soil deemed suitable by the COMPANY. General fill shall be free of trash, rubbish or other deleterious substances. The maximum particle size of general fill shall be 6 inches.

**2.3 LINER SUBGRADE**

- A. Liner Subgrade shall consist of soil excavated from the site during foundation grading. CONTRACTOR shall be responsible for loading, transporting, placement and compaction of Liner Subgrade.
- B. Liner Subgrade shall classify as CH or CL using ASTM D2487 and shall contain no organic material, sticks, or other deleterious material.
- C. The maximum particle size of liner subgrade shall be 3 inches. Particles larger than 1 inch shall be subrounded to rounded.

**2.4 COMPACTED CLAY**

- A. Compacted Clay shall consist of soil excavated from the COMPANY-designated Borrow Area or other COMPANY-approved off-site source. CONTRACTOR shall be responsible for loading, transporting, placement and compaction of Compacted Clay.
- B. Compacted Clay shall classify as CH or CL using ASTM D2487 and shall contain no organic material, sticks, or other deleterious material.
- C. Compacted Clay shall conform to the following:

Parameter	Specification
Plasticity Index	15 Minimum
Liquid Limit	30 Minimum
Percent Passing No. 200 Sieve	30% Minimum
Percent Passing 1.5-inch Sieve	100%
Hydraulic Conductivity	$1 \times 10^{-7}$ cm/s Maximum
In-Place Density	95% Standard Proctor Minimum
In-Place Moisture Content	-1% to +3% Optimum Moisture Content

**2.5 VEGETATIVE SOIL**

- A. Vegetative soil shall consist of soil stripped from the work area and stockpiled by the CONTRACTOR. Vegetative soil shall be free of deleterious material, materials toxic to plant growth, noxious weed seeds, rhizomes, roots, subsoil, rocks, or other debris.

**2.6 GRAVEL**

- A. Gravel shall be washed, angular crushed gravel or crushed limestone, free of mud, clay, vegetation or other debris, conforming to ASTM C33 for stone quality.
- B. Gravel shall have the following size gradation:

U.S. Sieve Size	Percent Passing
1.5 Inch	100
1 Inch	90 to 100
0.5 Inch	15 to 60
No. 4	0 to 10
No. 8	0 to 5

- C. Gravel shall conform to the following:
  - 1. Liquid Limit (LL) less than or equal to 35.
  - 2. Plasticity Index (PI) less than or equal to 10.

**2.7 ROAD BASE**

- A. Road base shall consist of crushed stone, free of mud, clay, vegetation or other debris, conforming to the requirements of TXDOT Item 248, Type A (Grade I). Size Gradation shall comply with the following:

U.S. Sieve Size	Percent Passing
2.5 inch	100
1.75 inch	100
0.875 inch	65 to 90
0.375 inch	50 to 70
No. 4	35 to 55
No. 40	15 to 30
No. 200	0

- B. Road Base shall conform to the following:
  - 1. Liquid Limit (LL) less than or equal to 35.
  - 2. Plasticity Index (PI) less than or equal to 10.

**2.8 RIPRAP**

- A. Riprap shall be clean, well-graded durable natural stone with a minimum specific gravity of 2.4.

Unless other wise approved by the COMPANY, riprap shall comply with the following:

1. No deleterious material, noxious weed seeds, roots, subsoil, or other debris shall be present.
2. Riprap shall consist of stone conforming to the following gradation:

Stone Weight (pounds)	Percent Lighter Than
700	100
300	50 to 100
150	15 to 50
45	0 to 15

3. Stones shall be at least 3 inches in their least dimension. The breadth or thickness of each stone shall not be less than one-third the length of the stone.

### **PART 3 - EXECUTION**

#### **3.1 GENERAL**

- A. All earthwork shall be completed to the lines and grades shown on the Drawings and as required by the COMPANY.
- B. CONTRACTOR shall not place material in the presence of water unless approved by the COMPANY. Saturated areas shall be dewatered by CONTRACTOR as specified herein prior to initiating earthwork activities. CONTRACTOR shall remove all saturated soils, muck, organic matter and other materials not suitable for compaction or proof-rolling from dewatered areas prior to placing fill materials.
- C. All proof rolling shall be performed as follows unless another method is approved by the COMPANY:
  1. Proof rolling equipment shall be approved by the COMPANY. Proof rolling equipment may be self-propelled or towed by a suitable tractor.
  2. Proof rolling equipment shall have a rolling width of 8 to 10 feet and shall be capable of operating under various contact pressures.
  3. Contact pressure of proof rolling equipment shall be a minimum of 2000 pounds per square foot.
  4. A minimum of two passes with the proof rolling equipment shall be completed across the entire native soil surface prior to placement of any material.
  5. Any area shown to be unstable or non-uniform after proof rolling shall be recompacted and/or reworked until proof rolled to the satisfaction of the COMPANY.
- D. Compaction of all materials shall be performed with an appropriately heavy, properly ballasted penetrating-foot compactor. A minimum of four passes of the compactor shall be performed on each material lift regardless of whether the lift complies with specified density requirements within less than four passes.
- E. When target compaction/density is specified using ASTM D698 (Standard Proctor), the minimum weight of the compacting equipment shall be 1500 pounds per linear foot of drum length.



- F. The daily work area shall extend a distance no greater than necessary to maintain moist conditions and continuous operations. Desiccation and crusting of the lift surface shall be avoided as much as possible.
- G. Water added to soils shall be clean and shall not have come into contact with waste or any objectionable material. Source of water shall be approved by COMPANY prior to application.
- H. Unless otherwise specified or approved by the COMPANY, the maximum clod size in each lift prior to compaction shall be 2 inches in diameter. Clod size shall be reduced through discing, pulverizing or similar methods. Unless otherwise approved by the COMPANY, a minimum of 4 passes with discing or pulverizing equipment shall be made across each lift prior to beginning compaction. A pass is defined as one trip across the lift surface. Passes shall be made at alternating right angles across the lift surface.
- I. Finished, compacted lifts of all material shall be sprayed with clean water as necessary to prevent drying and desiccation.
- J. At the end of each construction day's activities, completed lifts shall be sealed by rolling with a rubber-tired or smooth drum roller. Prior to resuming placement of overlying material, the surface of the previous lift shall be scarified to a minimum depth of 2 inches.

### **3.2 DEWATERING**

- A. CONTRACTOR shall note that some of the work may be performed in areas exhibiting saturated conditions at and below the groundwater table. CONTRACTOR shall not place material in the presence of water unless approved by the COMPANY.
- B. CONTRACTOR shall dewater the work area using pumps or other method approved by the COMPANY. Dewatering measures shall be implemented by the time the excavation reaches the water level in order to maintain the integrity of the in-situ material. Dewatering water shall be discharged in accordance with COMPANY requirements in a manner that minimizes erosion and other disturbances to existing drainage features and adjacent areas.
- C. All dewatering system components, including cofferdams, pumps, piping and related equipment shall be removed by the CONTRACTOR at the completion of the work.

### **3.3 COMPACTED CLAY**

- A. Construction of the Compacted Clay layer will begin after the underlying native soil has been finished to the proper lines and grade. The depth of the top of the underlying native soil prior to compacted clay construction shall coincide with the bottom of the Compacted Clay layer. The Compacted Clay layer shall be keyed into the underlying native soil or otherwise constructed to ensure stability.
- B. Compacted Clay shall be placed and compacted in lifts. Maximum loose lift thickness shall be 8 inches. Maximum compacted lift thickness shall be 6 inches.
- C. New Compacted Clay lifts shall be properly tied back into previous clay sections to ensure continuous clay layer coverage. Compacted Clay layers shall be tied into previously placed Compacted Clay layers using a stair-step construction method with benches, no steeper than a five horizontal to one vertical face.
- D. For excavation surfaces with a slope of 3(H):1(V) or flatter, Compacted Clay layer construction may utilize lifts parallel to the finished surface. For excavation surfaces that have steeper than 3(H):1(V) slopes, Compacted Clay lifts shall be placed in successive horizontal lifts. All horizontal lifts shall be sufficiently wide to safely accommodate construction equipment.

- E. Testing requirements for lifts placed on all sloped surfaces shall be the same as specified for non-sloped surfaces. Lift areas on sloped surfaces shall be measured parallel to the surface of the excavation.
- F. Prior to compaction of each lift, the moisture content of the Compacted Clay shall comply with the requirements of these specifications. If the moisture content is above the specified maximum, the Compacted Clay shall be pulverized, disced or similarly reworked to air dry the material and decrease the moisture content.
- G. Each lift shall be compacted to a minimum of 95 percent maximum dry density as determined by ASTM D698 (Standard Proctor). Material with densities less than the specified density shall be recompacted and/or reworked as necessary to achieve the specified density.
- H. Each lift shall be thoroughly compacted and shall satisfy all specified requirements before a subsequent lift is placed.
- I. After the final lift has been compacted and tested, the surface of the Compacted Clay shall be rolled and sealed with a smooth drum roller. A minimum of four passes of the roller shall be performed on the Compacted Clay. A pass is defined as one trip across the entire Compacted Clay surface.
- J. COMPANY will test Compacted Clay per the following guidelines:
  - 1. Pre-Construction Testing. Prior to beginning placement of the Compacted Clay, CONTRACTOR shall collect composite samples from the prospective clay source(s) and test the samples as described below. All composite samples shall consist of equal volumes of soil collected from a minimum of four locations within the prospective clay source.
    - a. Two soil classifications in accordance with ASTM D2487 shall be performed from each clay source. Plasticity Index (PI) shall be included in the soil classification.
    - b. Two moisture-density relationship tests in accordance with ASTM D698 (Standard Proctor) shall be performed from each clay source.
    - c. Two hydraulic conductivity tests by ASTM D5084 shall be performed from each clay source. Each sample shall be compacted to 95 percent maximum dry density as determined by ASTM D698 (Standard Proctor) prior to performing the hydraulic conductivity test.
  - 2. In-Place Testing. After each Compacted Clay lift has been placed, COMPANY will perform the following in-place tests:
    - a. One in-place density test in accordance with ASTM D6938 shall be performed per each 4,000 square feet for each lift.
    - b. One in-place moisture density relationship shall be reported for every in-place density test performed.
- K. After completion of the Compacted Clay layer, but before beginning installation of the overlying materials, CONTRACTOR shall survey the finished elevations of the Compacted Clay to ensure that the top of the Compacted Clay is at the grades and elevations specified on the Drawings. There shall be a minimum of one survey point for every 5,000 square feet of Compacted Clay surface area.

### **3.4 SELECT FILL**

- A. Select fill shall be placed and compacted in lifts. Maximum loose lift thickness shall be 8 inches.

Maximum compacted lift thickness shall be 6 inches.

- B. Prior to compaction, the moisture content of the select fill shall be no greater than plus 3 percent of the optimum moisture content as determined by ASTM D698 (Standard Proctor). If the moisture content is above the specified maximum, select fill shall be pulverized, disced or similarly reworked to air dry the material and decrease the moisture content.
- C. Each select fill lift shall be compacted to a minimum of 90 percent maximum dry density as determined by ASTM D698 (Standard Proctor). Material with densities less than the specified density shall be recompacted and/or reworked as necessary to achieve the specified density.
- D. Each lift shall be thoroughly compacted and shall satisfy all moisture and density requirements before a subsequent lift is placed.
- E. COMPANY will test select fill per the following guidelines:
  - 1. One moisture density relationship test in accordance with ASTM D698 (Standard Proctor) shall be performed for every 50,000 cubic yards placed.
  - 2. One in-place density test in accordance with ASTM D6938 shall be performed for every 20,000 square feet of surface area for each lift. Surface area shall be measured in the horizontal plane.
  - 3. One soil classification in accordance with ASTM D2487 shall be performed for every 50,000 cubic yards placed.
  - 4. Plasticity Index (PI) shall be included in the soil classification. One moisture-density relationship test in accordance with ASTM D698 (Standard Proctor) shall be performed any time a PI change greater than 10 is observed in the soil classification tests.
- F. After completion of the select fill, but before beginning installation of the overlying materials, CONTRACTOR shall survey the finished elevations of the select fill to ensure that the top of the select fill is at the grades and elevations specified on the Drawings. There shall be a minimum of one survey point for every 5,000 square feet of select fill surface area.

### **3.5 SELECT FILL ON STEEP SLOPES**

- A. Steep slopes are defined as surfaces with slopes steeper than 5 horizontal to 1 vertical.
- B. Construction of select fill on steep slopes shall comply with all other requirements for select fill, in addition to those specified herein.
- C. Select fill shall be placed and compacted in benched, horizontal lifts. Maximum loose lift thickness shall be 8 inches. Maximum compacted lift thickness shall be 6 inches.
- D. Lifts shall be placed and compacted horizontally (benched parallel to the toe of the slope) rather than vertically (up and down the slope). Each lift shall be wide enough to permit passage of compacting equipment.
- E. Lifts shall extend horizontally beyond the required final elevations of select fill to permit grading back to the required slopes after compaction and testing.
- F. After each lift has been compacted, tested and accepted by the COMPANY, Contractor shall grade the slope to the required elevations

### 3.6 LINER SUBGRADE

- K. Liner Subgrade shall be placed and compacted in lifts. Maximum loose lift thickness shall be 8 inches. Maximum compacted lift thickness shall be 6 inches. A total of 2 lifts will be placed to construct the 12 inch Liner Subgrade thickness.
- L. Prior to compaction of each of the lifts, CONTRACTOR shall manually remove all visible rock 3 inches or greater in size from the lift. After the visible rocks have been removed, CONTRACTOR shall compact each lift as discussed below.
- C. Prior to compaction of each lift, the moisture content of the Liner Subgrade shall be no greater than plus 4 percent of the optimum moisture content as determined by ASTM D698 (Standard Proctor). If the moisture content is above the specified maximum, Liner Subgrade shall be pulverized, disced or similarly reworked to air dry the material and decrease the moisture content.
- D. Each lift shall be compacted to a minimum of 90 percent maximum dry density as determined by ASTM D698 (Standard Proctor). Material with densities less than the specified density shall be recompacted and/or reworked as necessary to achieve the specified density.
- E. Each lift shall be thoroughly compacted and shall satisfy all specified requirements before a subsequent lift is placed.
- F. After the second lift has been compacted and tested, the surface of the Liner Subgrade shall be rolled and sealed with a smooth drum roller. A minimum of four passes of the roller shall be performed on the Liner Subgrade. A pass is defined as one trip across the entire Liner Subgrade surface.
- H. CONTRACTOR shall test Liner Subgrade as specified herein:
  - 1. One moisture density relationship test in accordance with ASTM D698 (Standard Proctor) shall be performed for every 10,000 cubic yards placed.
  - 2. One in-place density test in accordance with ASTM D6938 shall be performed for every 20,000 square feet of surface area for each lift. Surface area shall be measured in the horizontal plane.
  - 3. One soil classification in accordance with ASTM D2487 shall be performed for every 10,000 cubic yards placed.
  - 4. Plasticity Index (PI) shall be included in the soil classification. One moisture-density relationship test in accordance with ASTM D698 (Standard Proctor) shall be performed any time a PI change greater than 10 is observed in the soil classification tests.
  - 5. One hydraulic conductivity test by ASTM D5084 for every 10,000 cubic yards of Liner Subgrade. Each test shall be performed on a composite Liner Subgrade sample collected from the Liner Subgrade stockpile as approved by COMPANY. The composite sample shall be compacted to 90 percent maximum dry density as determined by ASTM D698 (Standard Proctor) prior to performing the hydraulic conductivity test.
- I. After completion of the Liner Subgrade, but before beginning installation of the overlying materials, CONTRACTOR shall survey the finished elevations of the Liner Subgrade to ensure that the top of the Liner Subgrade is at the grades and elevations specified on the Drawings. There shall be a minimum of one survey point for every 10,000 square feet of Liner Subgrade surface area.

### **3.7 VEGETATIVE SOIL**

- A. Vegetative Soil shall not be placed until the underlying soil has been approved by the COMPANY.
- B. Vegetative Soil shall be placed in one 12 inch lift without damaging the underlying soil. Vegetative Soil shall be tracked in and smoothed out using tracked equipment. No direct compactive effort shall be used on vegetative soil.
- C. After completion of the Vegetative Soil layer, CONTRACTOR shall survey the finished elevations of the Vegetative Soil to ensure that the top of the vegetative soil is at the grades and elevations specified on the Drawings. There shall be a minimum of one survey point for every 5,000 square feet of Vegetative Soil surface area.

### **3.8 ROAD BASE**

- A. Road Base shall be placed on access ramps, on the top of the dike and as required by the COMPANY.
- B. Geotextile shall be placed beneath all Road Base in accordance with Section 2430 of these specifications.
- C. Road Base shall be placed and compacted in lifts, with a maximum loose lift thickness of 8 inches. Each fill lift shall be compacted using a minimum of four passes of the compactor. A pass is defined as one trip across the lift surface. There is no target maximum density requirement for road base.
- D. After completion of the road base, but before beginning installation of the overlying materials, CONTRACTOR shall survey the finished elevations of the road base to ensure that the top of the road base is at the grades and elevations specified on the Drawings. There shall be a minimum of one survey point for every 5,000 square feet of road base surface area.

### **3.9 RIPRAP**

- A. Riprap shall be placed on geotextile conforming to the requirements of Section 02300 of these specifications. Place geotextile with the length running up and down the slope. Ensure geotextile has a minimum overlap of 2 feet at all seams.
- B. Riprap shall be placed in such manner as to produce a well graded mass of rock with the minimum practicable percentage of voids, and shall be constructed within a tolerance of plus 4 inches or minus 2 inches from the lines and grades shown on the Drawings. Placement shall begin at the bottom of the area to be covered and continue up slope. Subsequent loads of material shall be placed against previously placed material in such a manner as to ensure a relatively homogenous mass. Open joints shall be filled with spalls or small rocks. Rocks shall be arranged to present a uniform finished top surface such that the variation between tops of adjacent rocks shall not exceed 3 inches.
- C. No stone shall be dropped through air from a height greater than 3 feet on top of the geotextile. The larger stones shall be well distributed and the entire mass of stones in their final position shall be roughly graded to conform to the gradation specified in this specification. The finished riprap shall be free from objectionable pockets of small stones and clusters of larger stones. Placing riprap by dumping into chutes or by similar methods likely to cause segregation of the various sizes will not be permitted. Placing riprap by dumping it at the top of the slope and pushing it down the slope will not be permitted. Rearranging of individual stones will be required to the extent necessary to obtain a well-graded distribution of stone sizes as specified above.

++END OF SECTION++

**SECTION 02310**  
**CCR STABILIZATION**

**PART 1 - GENERAL**

**1.1 DESCRIPTION**

- A. This section shall govern work associated with grading, excavation, supply, hauling, placement and compaction of bridging lift.
- B. Work associated with the CCR stabilization shall also conform to Section 02300 – Earthwork of the Specifications.

**1.2 MATERIALS INCLUDED IN THIS SECTION**

- A. Bottom ash used for bridging lift
- B. Contractor-supplied material used for bridging lift

**1.3 RELATED SECTIONS**

- A. Section 02300 Earthwork
- B. Section 02320 Cap Subgrade

**1.4 REFERENCES**

- A. Reference Standards for bridging lift shall be as referenced in Section 02300 – Earthwork

**1.5 SUBMITTALS**

- A. Submittals for bridging lift shall be as specified in Section 02300 – Earthwork

**PART 2 - PRODUCTS**

**2.1 COAL COMBUSTION RESIDUALS AS BRIDGING LIFT**

- A. OWNER will supply CCR or existing CCR suitable for beneficial re-use within the surface impoundment for general site grading and use as bridging lift.
- B. OWNER will identify the location of CCR outside of the surface impoundment that may be used to supplement existing impounded materials. Contractor shall be responsible for loading, transporting, placement, and compaction of CCR used as bridging lift.
- C. Bridging lift shall be free of roots, brush, sod, or other perishable materials and debris.

**2.2 CONTRACTOR-SUPPLIED MATERIAL AS BRIDGING LIFT**

- A. Contractor-supplied bridging lift material shall be as specified herein.
- B. CCR suitable for re-use of contractor-supplied bridging lift material shall be approved by the Engineer prior to delivery to the Site.
- C. Contractor shall provide written Certification to Engineer that material to be supplied conforms to the requirements of this specification.

- D. Bridging lift shall be clean fill material free of waste material (other than CCR approved for beneficial re-use), organic material, sticks, or other deleterious material.
- E. Bridging lift may include crushed rock, broken rock, broken concrete and similar materials provided these materials do not exceed 30 percent (by weight) of the total material in the lift of which they are part.
- F. Contractor-supplied material shall be soil class "SC", "CL" or "CH" according to ASTM D2487 and shall conform to the following:
  - 1. No material larger than 3-inch diameter.
  - 2. Plasticity Index (PI) greater than or equal to 7.
  - 3. Particle size distribution shall conform to the following:

U.S. Sieve Size	Percent Passing
No. 4	80-95
No. 40	55-75
No. 200	Greater than 50

**PART 3 – EXECUTION**

**3.1 GENERAL**

- A. Compaction of all materials shall be performed with an appropriately heavy, properly ballasted penetrating foot compactor. A minimum of four passes of the compactor shall be performed on each material lift. A pass is defined as one trip of the compactor over the lift and back to the starting point by a single drum roller or one trip across the lift surface from one side to the other if the compacting equipment has front and back compacting rollers.
- B. The minimum weight of the compacting equipment shall be 1,500 pounds per linear foot of drum length.
- C. The daily work area shall extend a distance no greater than necessary to maintain moist conditions and continuous operations. Desiccation and crusting of the lift surface shall be avoided as much as possible.
- D. Water added to soils shall be clean and shall not have come into contact with waste or any objectionable material.

**3.2 CONSTRUCTION OF BRIDGING LIFT**

- A. All existing vegetation on areas to be capped or regraded shall be stripped or otherwise removed prior to placing bridging lift or regrading. Contractor shall be responsible for disposal of all debris resulting from vegetation removal in accordance with applicable laws and regulations.
- B. After existing vegetation has been removed, material underlying the bridging lift shall be graded to ± 1% slope prior to placement of bridging lift. Areas that only require regrading may not require compaction provided that such areas meet the requirements of Subsection 3.2.C of this Specification.
- C. Bridging lift underlying the cap subgrade shall conform to the following:
  - 1. Bridging lift shall be placed in three compacted lifts. The first lift shall be 12" and consist of bottom ash and/or select fill. The remaining two lifts shall each be 6" each and consist of select fill material. A minimum of four passes of the compacting equipment shall be required for each lift.

2. After the final lift has been placed and compacted to the required elevations, the bridging lift shall be proof rolled using the methods specified herein or other method approved by the Engineer:
    - a. Proof rolling equipment shall consist of not less than four pneumatic tired wheels, arranged so that the wheels carry approximately equal loads when operating on uneven surfaces. Proof rolling equipment may be self-propelled or towed by a suitable tractor.
    - b. Proof rolling equipment shall have a rolling width of 8 to 10 feet and shall be capable of operating under various contact pressures.
    - c. Contact pressure of proof rolling equipment shall be a minimum of 2,000 pounds per square foot.
    - d. A minimum of two passes with proof rolling equipment shall be completed across the entire prepared bridging lift surface.
  3. Any area of the bridging lift shown to be unstable or non-uniform after proof rolling shall be recompacted and/or reworked until proof rolled to the satisfaction of the ENGINEER.
- D. Finished lifts of bridging lift shall be sprayed with clean water as necessary to prevent drying and desiccation.
- E. At the end of each construction day's activities, completed lifts shall be sealed by rolling with a rubber-tired or smooth drum roller. Prior to resuming placement of material the surface of the bridging lift shall be scarified to a minimum depth of 2 inches.
- F. After completion of the bridging lift, but before beginning installation of the overlying cap subgrade, Contractor shall survey the finished elevations of the bridging lift to ensure that the top of the bridging lift is at the specified grades and elevations presented in the Conceptual Closure Plan. There shall be a minimum of one survey point for every 10,000 square feet of cap surface area.

++END OF SECTION++



## **SECTION 02320**

### **CAP SUBGRADE**

#### **PART 1 - GENERAL**

##### **1.1 DESCRIPTION**

- C. This section shall govern work associated with grading, excavation, supply, hauling, placement and compaction of cap subgrade material.
- D. Work associated with the cap subgrade shall also conform to Section 02300 – Earthwork of the Specifications.

##### **1.2 MATERIALS INCLUDED IN THIS SECTION**

- C. Existing Coal Combustion By-Products used as cap subgrade
- D. Contractor-supplied material used as cap subgrade

##### **1.3 RELATED SECTIONS**

- C. Section 02300 Earthwork
- D. Section 02330 Clay Cap

##### **1.4 REFERENCES**

- G. Reference Standards for cap subgrade shall be as referenced in Section 02300 – Earthwork

##### **1.5 SUBMITTALS**

- A. Submittals for cap subgrade shall be as specified in Section 02300 – Earthwork

#### **PART 2 - PRODUCTS**

##### **2.1 COAL COMBUSTION BY-PRODUCTS AS CAP SUBGRADE**

- A. OWNER will supply CCBs or existing CCBs within the landfill may be re-graded for use as cap subgrade.
- B. OWNER will identify the location of CCBs outside of the landfill that may be used to supplement existing landfilled materials. Contractor shall be responsible for loading, transporting, placement, and compaction of CCBs used as cap subgrade.
- C. Cap subgrade shall be free of roots, brush, sod, or other perishable materials and debris.

##### **2.2 CONTRACTOR-SUPPLIED MATERIAL AS CAP SUBGRADE**

- A. Contractor-supplied cap subgrade material shall be as specified herein.
- B. Cap subgrade material shall be approved by the Engineer prior to delivery to the Site.
- C. Contractor shall provide written Certification to Engineer that material to be supplied conforms to the requirements of this specification.
- D. Cap subgrade shall be clean fill material free of waste material, organic material, sticks, or other deleterious material.

- E. Cap subgrade may include crushed rock, broken rock, broken concrete and similar materials provided these materials do not exceed 30 percent (by weight) of the total material in the cap subgrade lift of which they are part.
- F. Contractor-supplied cap subgrade shall be soil class "CL" or "CH" according to ASTM D2487 and shall conform to the following:
  - 1. No material larger than 3-inch diameter.
  - 2. Plasticity Index (PI) greater than or equal to 7.
  - 3. Particle size distribution shall conform to the following:

U.S. Sieve Size	Percent Passing
No. 4	80-95
No. 40	55-75
No. 200	Greater than 50

**PART 3 – EXECUTION**

**3.1 GENERAL**

- A. Compaction of all materials shall be performed with an appropriately heavy, properly ballasted penetrating foot compactor. A minimum of four passes of the compactor shall be performed on each material lift. A pass is defined as one trip of the compactor over the lift and back to the starting point by a single drum roller or one trip across the lift surface from one side to the other if the compacting equipment has front and back compacting rollers.
- B. The minimum weight of the compacting equipment shall be 1,500 pounds per linear foot of drum length.
- C. The daily work area shall extend a distance no greater than necessary to maintain moist conditions and continuous operations. Desiccation and crusting of the lift surface shall be avoided as much as possible.
- D. Water added to soils shall be clean and shall not have come into contact with waste or any objectionable material.

**3.2 CONSTRUCTION OF CAP SUBGRADE**

- A. All existing vegetation on areas to be capped or regraded shall be stripped or otherwise removed prior to placing cap subgrade or regarding. Contractor shall be responsible for disposal of all debris resulting from vegetation removal in accordance with applicable laws and regulations.
- H. After existing vegetation has been removed, material underlying the cap subgrade shall be scarified to a minimum depth of 2-inches prior to placement of cap subgrade. Areas that only require regarding may not require scarifying and compaction provided that such areas meet that are regarded to meet the requirements of Subsection 3.2.C of this Specification.
- I. Cap subgrade underlying the clay cap shall conform to the following:
  - 4. Cap subgrade shall be placed in compacted lifts. Maximum loose lift thickness shall be 12 inches and a minimum of four passes of the compacting equipment shall be required for each lift.

5. After the final lift has been placed and compacted to the required elevations, the cap subgrade shall be proof rolled using the methods specified herein or other method approved by the Engineer:
  - a. Proof rolling equipment shall consist of not less than four pneumatic tired wheels, arranged so that the wheels carry approximately equal loads when operating on uneven surfaces. Proof rolling equipment may be self-propelled or towed by a suitable tractor.
  - b. Proof rolling equipment shall have a rolling width of 8 to 10 feet and shall be capable of operating under various contact pressures.
  - c. Contact pressure of proof rolling equipment shall be a minimum of 2,000 pounds per square foot.
  - d. A minimum of two passes with proof rolling equipment shall be completed across the entire prepared cap subgrade surface.
6. Any area of the cap subgrade shown to be unstable or non-uniform after proof rolling shall be recompacted and/or reworked until proof rolled to the satisfaction of the ENGINEER.
- J. Finished lifts of cap subgrade shall be sprayed with clean water as necessary to prevent drying and desiccation.
- K. At the end of each construction day's activities, completed lifts shall be sealed by rolling with a rubber-tired or smooth drum roller. Prior to resuming placement of material the surface of the cap subgrade shall be scarified to a minimum depth of 2 inches.
- L. After completion of the cap subgrade, but before beginning installation of the overlying clay cap, Contractor shall survey the finished elevations of the cap subgrade to ensure that the top of the cap subgrade is at the specified grades and elevations presented in the Conceptual Closure Plan. There shall be a minimum of one survey point for every 10,000 square feet of cap surface area.

++END OF SECTION++

## **SECTION 02330**

### **CLAY CAP**

#### **PART 1 - GENERAL**

##### **3.3 DESCRIPTION**

- A. This section shall govern work associated with grading, excavation, supply, hauling, placement and compaction of the clay cap material.
- B. Work associated with the cap subgrade shall also conform to Section 02300 – Earthwork of the Specifications.

##### **3.4 MATERIALS INCLUDED IN THIS SECTION**

- A. OWNER-supplied material used as clay cap
- B. Contractor-supplied material used as cap subgrade

##### **3.5 RELATED SECTIONS**

- A. Section 02300 Earthwork
- B. Section 02330 Clay Cap

##### **3.6 REFERENCES**

- A. Reference Standards for cap subgrade shall be as referenced in Section 02300 – Earthwork

##### **1.5 SUBMITTALS**

- A. Submittals for cap subgrade shall be as specified in Section 02300 – Earthwork

#### **PART 2 - PRODUCTS**

##### **2.1 COAL COMBUSTION BY-PRODUCTS AS CAP SUBGRADE**

- A. OWNER may identify a suitable on-site borrow area for supplying clay cap material.
- B. OWNER will identify the location of suitable material that may be used as clay cap. Contractor shall be responsible for loading, transporting, placement, and compaction of material used as the clay cap.
- C. Clay cap material shall be free of roots, brush, sod, or other perishable materials and debris.

##### **2.2 CONTRACTOR-SUPPLIED MATERIAL AS CLAY CAP**

- A. Contractor-supplied clay cap material shall be as specified herein.
- B. Cap material shall be approved by the Engineer prior to delivery to the Site.
- C. Contractor shall provide written Certification to Engineer that material to be supplied conforms to the requirements of this specification.
- D. Clay cap shall be clean fill material free of waste material, organic material, sticks, or other

deleterious material.

- E. Contractor-supplied clay cap shall be soil class "CL" or "CH" according to ASTM D2487 and shall conform to the following:
1. No material larger than 3-inch diameter.
  2. Plasticity Index (PI) greater than or equal to 15.
  3. In-place permeability by ASTM D5084 no greater than  $1 \times 10^{-7}$  cm/sec
  4. All material retained on the No. 4 Sieve shall be subrounded to rounded.
  5. Particle size distribution shall conform to the following:

U.S. Sieve Size	Percent Passing
No. 4	80-95
No. 40	55-75
No. 200	Greater than 50

### **PART 3 – EXECUTION**

#### **3.1 GENERAL**

- A. Compaction of all materials shall be performed with an appropriately heavy, properly ballasted penetrating foot compactor. A minimum of four passes of the compactor shall be performed on each material lift. A pass is defined as one trip of the compactor over the lift and back to the starting point by a single drum roller or one trip across the lift surface from one side to the other if the compacting equipment has front and back compacting rollers.
- B. The minimum weight of the compacting equipment shall be 1,500 pounds per linear foot of drum length.
- C. The daily work area shall extend a distance no greater than necessary to maintain moist conditions and continuous operations. Desiccation and crusting of the lift surface shall be avoided as much as possible.
- D. Water added to soils shall be clean and shall not have come into contact with waste or any objectionable material.

#### **3.2 CONSTRUCTION OF CAP SUBGRADE**

- A. Clay cap shall be placed and compacted with a maximum loose lift thickness of 8 inches and a maximum compacted lift thickness of 6 inches.
- B. The clay cap shall be compacted as necessary to achieve an in-place permeability of no greater than  $1 \times 10^{-7}$  cm/second. At a minimum, four passes of the compacting equipment shall be required for each lift.
- G. Contractor shall test the clay cap as specified herein:
  1. Two soil classifications in accordance with ASTM D2487 shall be performed for each lift.
  2. One in-place density test in accordance with ASTM D2922 shall be performed for every 20,000 square feet of cap subgrade placed for each 12 inches of compacted thickness.

3. One permeability test in accordance with ASTM D5084 shall be performed for every 4 acres of cap subgrade placed for each 12 inches of compacted thickness.
- H. Finished lifts of cap subgrade shall be sprayed with clean water as necessary to prevent drying and desiccation.
  - I. At the end of each construction day's activities, completed lifts shall be sealed by rolling with a rubber-tired or smooth drum roller. Prior to resuming placement of material the surface of the cap subgrade shall be scarified to a minimum depth of 2 inches.
  - J. After completion of the cap subgrade, but before beginning installation of the overlying clay cap, Contractor shall survey the finished elevations of the cap subgrade to ensure that the top of the cap subgrade is at the specified grades and elevations presented in the Conceptual Closure Plan. There shall be a minimum of one survey point for every 10,000 square feet of cap surface area.

++END OF SECTION++

LUMINANT

## SECTION 02340

### VEGETATIVE SOIL LAYER

#### PART 1 - GENERAL

##### 1.1 DESCRIPTION

- A. This section shall govern work associated with grading, excavation, supply, hauling, placement and compaction of the vegetative soil material.
- B. Work associated with the vegetative soil layer shall also conform to Section 02300 – Earthwork of the Specifications.

##### 1.2 MATERIALS INCLUDED IN THIS SECTION

- A. OWNER-supplied material used as vegetative soil
- B. Contractor-supplied material used as vegetative soil

##### 1.3 RELATED SECTIONS

- A. Section 02300 Earthwork
- B. Section 02330 Clay Cap
- C. Vegetation

##### 1.4 REFERENCES

- A. Reference Standards for vegetative soil layer shall be as referenced in Section 02300 – Earthwork

##### 1.5 SUBMITTALS

- A. Submittals for cap subgrade shall be as specified in Section 02300 – Earthwork

#### PART 2 - PRODUCTS

##### 2.1 OWNER-SUPPLIED MATERIAL AS VEGETATIVE SOIL LAYER

- A. OWNER will supply Contractor with material for use as vegetative soil layer.
- B. OWNER will identify the location of material for Contractor. Contractor shall be responsible for loading, transporting, placement, and compaction of material used as the vegetative soil layer.

##### 2.2 CONTRACTOR-SUPPLIED MATERIAL AS VEGETATIVE SOIL LAYER

- A. Vegetative soil layer shall be a clay loam or silty clay loam as classified by the United States Department of Agriculture and shall comply with all of the following:
  - 1. Free of deleterious material, materials toxic to plant growth, noxious weed seeds, rhizomes, roots, subsoil, rocks, or other debris.
  - 2. Maximum sodium adsorption ration (SAR): 8
  - 3. Maximum electrical conductivity (EC): 2 mmhos/cm

4. Maximum particle dimension: 2 inches.
5. The pH shall be between 6.0 and 8.5 standard units. If approved by the Engineer, Contractor may amend soil as necessary to achieve the specified pH.

### **PART 3 - EXECUTION**

#### **3.1 VEGETATIVE SOIL LAYER PLACEMENT**

- A. Vegetative Soil shall not be placed until the underlying soil has been approved by the ENGINEER.
- B. Vegetative Soil shall be placed in one 18 inch lift without damaging the underlying soil. Vegetative Soil shall be tracked in and smoothed out using tracked equipment. No direct compactive effort shall be used on vegetative soil.
- C. After completion of the Vegetative Soil layer, CONTRACTOR shall survey the finished elevations of the Vegetative Soil to ensure that the top of the protective soil is at the grades and elevations specified on the Drawings. There shall be a minimum of one survey point for every 10,000 square feet of Vegetative Soil surface area.

++END OF SECTION++

LUMINANT



**SECTION 02350**

**VEGETATION**

**PART 1 – GENERAL**

**1.1 SUMMARY**

- A. This Section describes the requirements for vegetation establishment in areas disturbed during construction activities.

**1.2 SUBMITTALS**

- A. CONTRACTOR shall submit information regarding proposed seed, fertilizer, mulch, tackifier and any other materials to be used to establish vegetation at least 10 days prior to delivery.

**PART 2 – PRODUCTS**

**2.1 SEED SUPPLIERS**

- A. Seed suppliers must provide labeling of variety, purity, and germination. The supplier must satisfy State of Texas seed quality laws. The COMPANY must approve seed supplier.

**2.2 SEED DELIVERY, STORAGE, AND HANDLING**

- A. Grass seed mixture shall be delivered in sealed containers. Seed in damaged packaging will not be accepted. CONTRACTOR shall provide seed mixture in containers showing the percentage of each species in the seed mix, year of production, net weight, date of packaging, name and address of supplier, percent of weed seed content, and guaranteed percentage of purity and germination.
- B. Fertilizer shall be delivered in appropriate waterproof containers showing weight, chemical analysis, and name of manufacturer.

**2.3 SEED MIXTURE**

- A. Seed mixture shall be appropriate for the season in which it is planted and shall be approved by the COMPANY prior to placement.
- B. Seed shall be hulled, extra-fine grade, treated with fungicide, and shall have a germination and purity that will produce, after allowance for Federal Seed Act tolerances, a pure live seed (PLS) content of not less than 85 percent. Seed shall be labeled in accordance with U.S. Department of Agriculture rules and regulations.
- C. Unless otherwise approved by the COMPANY, vegetation seed mixture shall consist of the following grasses at the application rates specified:

Grass Species	Application Rate (pounds PLS per acre)
Gulf Rye	30
Common Bermudagrass	20
Total:	50

- D. Alternative seed mixtures may be submitted in writing to the COMPANY and must be approved by the COMPANY prior to seed application.

## **2.4 ACCESSORIES**

- A. Mulching materials shall consist of dry oat, wheat, or Bermuda straw, free from weeds and foreign matter detrimental to plant life. Native hay or chopped cornstalks are acceptable. Also acceptable is approved chip-form wood cellulose fiber that is free of ingredients that could inhibit growth or germination.
- B. Compost, if used as an organic admixture, shall be applied per TXDOT Special Specification; Item 1027 "Furnishing and Placing Compost." Compost application is optional and subject to the approval of the COMPANY, which must be obtained at least 10 days prior to use.
- C. Fertilizer shall be applied to vegetative soil layer material and shall be inorganic chemical fertilizer consisting of 20-5-5 fertilizer applied at 200 pounds per acre.
- D. Stakes shall be softwood lumber, chisel pointed.
- E. Water shall be from fresh water sources and shall be free from soil, acids, alkalis, salt, or any other substance injurious to growth of grass.

## **PART 3 – EXECUTION**

### **3.1 INSPECTION OF VEGETATIVE SOIL**

- A. CONTRACTOR shall verify that vegetative soil and areas disturbed during construction activities are ready to receive the work covered by this section.

### **3.2 FERTILIZER**

- A. All fertilizer shall be applied in accordance with manufacturer's instructions.
- B. Manure, if used, may be applied at a rate of up to 10 tons/acre. Manure application is optional subject to the approval of the COMPANY, which must be obtained at least 10 days prior to use.
- C. Pre-planting fertilizer shall be mixed thoroughly into the upper 3 in. of vegetative-soil layer prior to applying seed.

### **3.3 SEEDING**

- A. Drill seed application is acceptable for slopes equal to or flatter than 4(H):1(V).
- B. Seed shall be applied evenly by broadcast or hydroseed application at the rate specified in this Section. Adjustment to rate shall be made for variations in seed purity and germination to achieve the PLS equivalent rate. Hydroseeding is acceptable as a broadcast method of seeding and fertilizing. If dry broadcasting is done, seeds must be raked into the upper soil surface and seed must be applied at half of the specified broadcast rate. Designated areas for erosion control may not be seeded in excess of that which can be covered with erosion control material on the same day.
- C. CONTRACTOR shall not sow immediately following rain, when ground is too dry, or during windy periods.

### **3.4 SEED PROTECTION/EROSION CONTROL**

- A. Straw/hay mulch shall be applied to all seeded areas, with slopes less than 4(H) to 1(V), within 24 hours after seeding operations. Straw or hay mulch shall be applied at a rate of approximately 150 pounds per 1000 square feet (6,500 pounds per acre) and crimped in place. Cellulose fiber

mulch shall be applied at a rate of approximately 75 pounds per 1,000 square feet (3,200 pounds per acre).

- B. Seeded sloped areas shall be covered with erosion control fabric on all exterior slopes of 4(H) to 1(V) and steeper; and in all drainage channels and swales in accordance with Section 1100, "Erosion and Sedimentation Control."

### **3.5 IRRIGATION**

- A. CONTRACTOR shall irrigate seeded areas if and as necessary to comply with the Uniform Grass Coverage (UGC) requirements of this Section.
- B. Irrigation may be performed by water truck or by temporary irrigation system. If a temporary irrigation system is used, CONTRACTOR shall remove temporary irrigation system once COMPANY has accepted vegetated areas.
- C. Irrigation shall be performed for a minimum of thirty days after initial planting and for as long as necessary to establish UGC across the entire seeded area.

### **3.6 ESTABLISHMENT AND ACCEPTANCE OF PERMANENT VEGETATION**

- A. It shall be solely the CONTRACTOR's responsibility to establish UGC across all application areas, regardless of unseasonable climatic conditions or other adverse conditions affecting planting operations and growth of vegetation.
- B. Uniform Grass Coverage (UGC) shall be defined as a uniform stand of the specified grass with not less than 12 growing plants per square foot of seeded areas.
- C. COMPANY will consider application areas acceptable only when:
  - 1. A statistically significant number of randomly sampled plots have an average of 12 growing plants per square foot.
  - 2. A minimum of one mowing has been performed in the seeded areas.
  - 3. UGC has been deemed to have been achieved by the COMPANY.
- D. Any application areas, which are not determined to be acceptable by the COMPANY, shall be replanted, refertilized, and reirrigated at no additional cost to the COMPANY.
- E. The life and satisfactory condition of all plants (including grass) shall be guaranteed by CONTRACTOR for a period of up to one calendar year after written notice of first acceptance of vegetation by COMPANY. The guarantee period shall include one complete growing season and dormant period.

++END OF SECTION++

## SECTION 02420

### FLEXIBLE MEMBRANE LINER

#### PART 1 - GENERAL

##### 1.1 DESCRIPTION

- A. This section shall govern work associated with furnishing and installing Flexible Membrane Liner, including, but not limited to, layout, placement, seaming, patching and testing.

##### 1.2 REFERENCES

- A. American Society of Testing Materials (ASTM) Standards/Publications (Latest version):
- |        |  |
|--------|--|
| D 638  | Standard Test Method for Tensile Properties of Plastics  |
| D 1004 | Test Method for Initial Tear Resistance of Plastic or Film Sheeting  |
| D 1238 | Standard Test Method for Flow Rates of Thermoplastics by Extrusion Plastometer   |
| D 1505 | Test Method for Density of Plastics by the Density-Gradient Technique  |
| D 1603 | Test Method for Carbon Black in Olefin Plastics  |
| D 2216 | Test Method for Laboratory Determination of Water (Moisture) Content of Soil, Rock, and Soil-aggregate Mixtures                                    |
| D 3895 | Standard Test Method for Oxidative-Induction Time of Polyolefins by Differential Scanning Calorimetry  |
| D 4354 | Standard Practice for Sampling of Geosynthetics for Testing  |
| D 4632 | Standard Test Method for Grab Breaking Load and Elongation of Geotextiles  |
| D 4643 | Standard Test Method for Determination of Water (Moisture) Content of Soil by the Microwave Oven Method  |
| D 4759 | Standard of Practice for Determining the Specification Conformance of Geosynthetics  |
| D 4833 | Standard Test Method for Index Puncture Resistance of Geotextiles, Geomembranes and Other Related Products.  |
| D 5084 | Test Method for Measurement of Hydraulic Conductivity of Saturated Porous Materials Using a Flexible Wall Permeameter                              |
| D 5199 | Measuring Nominal Thickness of Geotextiles and Geomembranes  |
| D 5261 | Standard Test Method for Measuring Mass Per Unit Area of Geotextiles   |
| D 5321 | Standard Test Method for Determining the Coefficient of Soil and Geosynthetic or Geosynthetic and Geosynthetic Friction by the Direct Shear Method |
| D 5397 | Standard Test Method for Evaluation of Stress Crack Resistance of Polyolefin Geomembranes Using Notched Constant Tensile Load Test                 |

- D 5596 Standard Test Method for Microscopic Evaluation of the Dispersion of Carbon Black in Polyolefin Geosynthetics
  - D 5641 Standard Practice for Geomembrane Seam Evaluation by Vacuum Chamber
  - D 5820 Standard Practice for Pressurized Air Channel Evaluation of Dual Seamed Geomembranes
  - D 5887 Test Method for Measurement of Index Flux through Saturated Geosynthetic Clay Liner Using Flexible Wall Permeameter
  - D 5888 Identification, Storage, and Handling of Geosynthetic Clay Liners
  - D 5889 Standard Practice for Quality Control of Geosynthetic Clay Liners
  - D 5890 Test Method for Swell Index of Clay Mineral Component of Geosynthetic Clay Liners
  - D 5891 Standard Test Method for Fluid Loss of Clay Component of Geosynthetic Clay Liners
  - D 5993 Standard Test Method for Measuring Mass Per Unit Area of Geosynthetic Clay Liners
  - D 5994 Standard Test Method for Measuring Core Thickness of Textured Geomembranes
  - D 6102 Standard Guide for Installation of Geosynthetic Clay Liners
  - D 6243 Standard Test Method for Determining the Coefficient of Soil and GCL or Geosynthetic and GCL Friction by the Direct Shear Method
  - D 6392 Standard Test Method for Determining the Integrity of Nonreinforced Geomembrane Seams Produced Using Thermo-Fusion Methods
  - D 6496 Standard Test Method for Determining Average Bonding Peel Strength Between the Top and Bottom Layers of Needle-Punched Geosynthetic Clay Liners
  - D 6693 Standard Test Method for Determining Tensile Properties of Nonreinforced Polyethylene and Nonreinforced Flexible Polypropylene Geomembranes
  - D 6768 Standard Test Method for Tensile Strength of Geosynthetic Clay Liners
  - E 96 Standard Test Methods for Water Vapor Transmission of Materials
- B. Geosynthetic Research Institute (GRI)
- GM 17 Test Properties, Testing Frequency and Recommended Warranty for Linear Low Density Polyethylene (LLDPE) Smooth and Textured Geomembranes

### 1.3 DEFINITIONS

- A. Flexible Membrane Liner (FML) - An essentially impermeable flexible geomembrane liner of linear low density polyethylene (LLDPE).

- B. INSTALLER -Party responsible for liner installation, including handling, transporting, storing, deploying, protecting, sampling, patching damaged liner and temporary restraining against wind and thermal/solar expansion.
- C. Lot - Group of consecutively numbered rolls from the same manufacturing line.
- D. MANUFACTURER - Party responsible for the production and quality of the liner.
- E. Overlap - The width of material of a liner panel in contact with an adjacent liner panel. The overlap distance is measured perpendicular from the overlying edge of one panel to the underlying edge of the other.

#### **1.4 SUBMITTALS**

- A. CONTRACTOR shall submit the following product information at least 10 days prior to delivery:
  - 1. FML: Certification stating that the FML meets the product requirements of this specification and copies of quality control tests performed by MANUFACTURER.
- B. CONTRACTOR shall submit the name of the INSTALLER at least 3 weeks prior to installation, including resume of installation supervisor to be assigned to the project and a list of FML projects completed by INSTALLER.
- C. CONTRACTOR shall submit a Quality Control Plan and Installation Procedures at least 3 weeks prior to installation. The information shall include a list of quality control tests performed and typical testing frequencies, recommended installation procedures, and panel layout drawing identifying panels and overlaps.
- D. CONTRACTOR shall submit the following upon completion of the FML installation:
  - 1. Certification from the INSTALLER stating that the FML has been installed in accordance with the Drawings and Specifications.
  - 2. As-built record drawings showing instrument surveyed locations of all panels, seams, repairs, patches and test samples.
  - 3. Test reports verifying that the FML has been installed in accordance with the specified requirements.
  - 4. Test reports verifying completion of all field seams and repairs are in accord with specified requirements.

#### **1.5 QUALIFICATIONS**

- A. INSTALLER must have experience installing FML liners on at least 5 projects of each liner type and have installed a minimum of 2,000,000 square feet of each liner type.
- B. INSTALLER shall provide a minimum of one Master Seamer (minimum 1,000,000 square feet using the type of seaming apparatus proposed for this project) for work on the project.
- C. MANUFACTURER may serve as the INSTALLER or may use an outside INSTALLER that has been approved and certified by MANUFACTURER.

#### **1.6 QUALITY CONTROL**

- A. CONTRACTOR is responsible for the overall quality of the installed FML. CONTRACTOR shall maintain quality control over suppliers, manufacturers, products, services, site conditions, and workmanship, to produce Work of specified quality.

- B. CONTRACTOR shall perform construction surveys, as needed, to ensure that the location and grades of all liner installations are in accordance with the design requirements.
- C. ENGINEER may perform periodic quality assurance monitoring above and beyond that specified herein. CONTRACTOR shall cooperate, as required, in quality assurance monitoring.

**1.8 WARRANTY**

- A. FML material shall be warranted by the MANUFACTURER on a pro-rata basis against defects for a period of 5 years from the date of acceptance by the COMPANY.
- B. FML installation shall be warranted by the INSTALLER against defects in workmanship for a period of 1 year from the date of acceptance by the COMPANY.

**PART 2 - PRODUCTS**

**2.1 FML PRODUCT STANDARD**

- A. FML shall be Type “UltraFlex” as manufactured by GSE Environmental, Inc. (GSE) of Houston, Texas; or ENGINEER-approved equivalent. The FML shall be a black, coextruded geomembrane.
- B. Smooth FML shall be installed on flat surfaces and slopes less than 4(H) to 1(V). Textured FML shall be installed on slopes 4(H) to 1(V) and steeper.

**C. FML Material Properties**

- 1. FML shall be 40 mil thick linear low density polyethylene (LLDPE) and shall comply with the following:

Property	ASTM Method	Frequency	Unit	Minimum Average Values
Thickness	D5994	Every Roll	mil	40
Density	D1505	200,000 lbs	g/cm <sup>3</sup>	0.94
Tensile Break Strength (smooth/textured)	D6693	20,000 lbs	lb/in	152/60
Elongation at Break (smooth/textured)	D6693	20,000 lbs	%	800/250
Tear Resistance	D1004	45,000 lbs	lb	22
Puncture Resistance (smooth/textured)	D4833	45,000 lbs	lb	56/44
Carbon Black Content	D1603	20,000 lbs	%	2.0 – 3.0
Notch Constant Tensile Load	D5397	200,000 lbs	hr	300
Oxidative Induction Time	D3895	200,000 lbs	min	>100

- D. FML Extrudate Rod or Bead shall conform to the following:
  - 1. Extrudate material shall be made from same type resin as the FML.
  - 2. Additives shall be thoroughly dispersed.

3. Materials shall be free of contamination by moisture or foreign matter.

E. FML Welding/Seaming Equipment shall meet the following requirements:

1. Gauges showing temperatures in apparatus (extrusion welder) or wedge (wedge welder) shall be present.
2. An adequate number of welding apparatus shall be available to avoid delaying work.
3. Power source must be capable of providing constant voltage under combined line load.

## **2.2 FML PACKING AND LABELING**

A. FML shall be wrapped around a structurally sound core than can support the weight of the liner. Liners shall be supplied in rolls wrapped in relatively impermeable and opaque protective covers and marked or tagged with the following information:

1. MANUFACTURER's name
2. product identification
3. lot or batch number
4. roll number
5. roll dimensions

## **2.3 FML MANUFACTURING QUALITY CONTROL**

- A. FML shall be subjected to quality control and conformance testing to assure that the materials provided meet the specified requirements. Where possible, sampling shall be performed on sacrificial portions of the material to minimize repair of sampled locations.
- B. All materials shall be tested in accordance with MANUFACTURER's quality control program and as specified herein. The MANUFACTURER shall perform the testing. Samples not satisfying the requirements of these specifications shall result in the rejection of the applicable rolls. At CONTRACTOR's expense, additional testing of individual rolls may be performed to more closely identify the non-complying rolls and/or to qualify individual rolls.

## **PART 3 - EXECUTION**

### **3.1 DELIVERY, STORAGE and HANDLING**

- A. Deliver material to the job site only after ENGINEER/COMPANY accepts required submittals.
- B. Comply with MANUFACTURER'S recommendations regarding product protection. Maintain product clean and free of damage.
- C. Liner shall be covered with a waterproof, tight-fitting plastic protective covering resistant to ultraviolet degradation. Damage to protective covering shall be repaired immediately. Repairs shall be such that the liner is protected from moisture or other deleterious conditions.
- D. Deliver product to the job site in MANUFACTURER's original packaging, with labels intact and legible. Maintain packaged materials with seals unbroken and labels intact until time of use. Promptly remove damaged or unsuitable products from the job site and promptly replace with products meeting the required specifications.
- E. Comply with MANUFACTURER's recommendations when hauling, unloading, deploying, and installing liner. Do not fold liner. Inspect for defects before installing.

### **3.2 FML DEPLOYMENT**

- A. MANUFACTURER shall verify to the ENGINEER that the materials upon which the FML will be installed are acceptable prior to initiating FML deployment.



- B. Assign each panel a simple and logical identifying code. The coding system shall be subject to approval by the ENGINEER and shall be determined at the job site.
- C. Visually inspect the FML during deployment for imperfections and mark faulty or suspect areas.
- D. Deployment of FML panels shall be performed in a manner that will comply with the following guidelines:
  - 1. Unroll FML using methods that will not damage FML and will protect underlying surface from damage (spreader bar, protected equipment bucket).
  - 2. Place ballast (commonly sandbags) on FML which will not damage FML to prevent wind uplift.
  - 3. Personnel walking on FML shall not engage in activities or wear shoes that could damage it. Smoking will not be permitted on the FML.
  - 4. Do not allow heavy vehicular traffic directly on FML. Rubber-tired ATV's and trucks are acceptable if wheel contact is less than 6 psi.
  - 5. Protect FML in areas of heavy traffic by placing protective cover over the FML.
- E. Sufficient material (slack) shall be provided to allow for thermal expansion and contraction of the material.
- F. During installation avoid bridging, stresses in the FML, wrinkles and folds.
- G. Schedule FML deployment so deployment, welding and covering occur within as narrow a temperature range as possible. Do not deploy in the presence of excessive moisture, precipitation, ponded water or high winds.
- H. Deploy panels to minimize field seams in corners, odd-shaped geometric locations and outside corners.
- I. Shingle panels on slopes and grades so upgradient panel is on top.
- J. Unroll only those factory-packaged sections which are to be anchored or seamed together in one day.
- K. After panels are initially in place, remove as many wrinkles as possible. Unroll several panels and allow the liner to "relax" before beginning field seaming. The purpose of this is to make the edges which are to be bonded as smooth and free of wrinkles as possible.
- L. Once panels are in-place and smooth, commence field seaming operations.
- M. Personnel working on the FML shall not smoke, wear damaging shoes or engage in any activity which damages the FML.
- N. Anchor trenches shall be constructed as shown on the Drawings. Round edges of anchor trenches or cushion with geotextile. The anchor trench shall be excavated, backfilled and compacted in accordance with MANUFACTURER's recommendations. Care should be taken when backfilling the trench to prevent any damage to the FML.
- O. Damaged and sample coupon areas of FML shall be repaired by the CONTRACTOR before leaving the site at the end of each day. Any damage to subgrade while coupons are open is the responsibility of the CONTRACTOR. Repaired areas will be tested for seam integrity by the CONTRACTOR. Damaged materials are the property of the CONTRACTOR and will be removed

from the site at the CONTRACTOR's expense. The CONTRACTOR will retain all ownership and responsibility for the FML until acceptance by the COMPANY.

### 3.3 FML SEAMING

- A. Provide at least one Master Seamer who shall provide direct supervision over other welders as necessary.
- B. Use a sequential seam numbering system compatible with panel numbering system that is acceptable to the ENGINEER and INSTALLER.
- C. Seaming may be extrusion or wedge welding or a combination of these methods. Solvent welding is not acceptable. ENGINEER reserves the right to reject any proposed seaming method.
  - 1. Extrusion Welding. Extrusion welding applies a molten bead of material to preheated sheets of FML which are then joined by pressure. Prior to extrusion welding:
    - a. Hot-air tack adjacent pieces together using procedures that do not damage the FML.
    - b. Clean FML surfaces by disc grinder or equivalent.
    - c. Purge welding apparatus of heat-degraded extrudate before welding.
  - 2. Wedge Welding. The wedge welding process heats the FML area to be joined to the melting point and then applies pressure to join the melted surfaces. Wedge welding apparatus shall be a self-propelled device equipped with an electronic controller which displays applicable temperatures.
- D. Seaming shall be performed in accordance with the following:
  - 1. All foreign matter (dirt, water, oil, etc) shall be removed from the area to be bonded. No solvents shall be used to clean the FML.
  - 2. It is imperative to keep surface water runoff from beneath the FML at all times during installation. The CONTRACTOR's panel placement, seam welding technique and welding schedule shall minimize or eliminate the accumulation of water beneath the FML. Any water found ponded beneath the FML after the FML has been installed shall be removed by the CONTRACTOR at no cost to the COMPANY. Subgrade beneath FML that has become excessively moist, soft or unsuitable to perform its intended function shall be replaced at no cost to the COMPANY.
  - 3. As much as practical, field seaming shall start in the middle and work toward an open end in order to minimize cutting and patching of large wrinkles that become trapped. When seaming the side slopes, seaming should start at the toe of the slope and work up the slope. Tack welds, if used, shall use heat only; no double-sided tape, glue or other method will be permitted. The FML should be seamed completely to the ends of all panels to minimize the potential of tear propagation along the seam. Seaming of the bottom membrane to the sidewall membrane shall be conducted when conditions minimize thermal expansion effects. The completed liner shall not exhibit "trampolineing" and shall be in full contact with the underlying materials.
  - 4. FML sheets to be joined shall be overlapped at least 6-inches after the necessary aligning and cutting, unless otherwise shown on the Contract Drawings.
  - 5. In corners and odd shaped geometric locations, the number of field seams should be minimized.
  - 6. No seaming should be attempted above 40 degrees C (104 degrees F) ambient air temperature. Below 5 degrees C (41 degrees F) ambient air temperature, preheating of

the FML may be required. It shall be the responsibility of the CONTRACTOR to demonstrate that conditions are favorable for seaming by acceptable test (start-up) seams which duplicate, as closely as possible, actual field conditions. Preheating may be achieved by natural and/or artificial means (shelters and heating devices).

7. A moveable protective layer of plastic may be required, as recommended by the ENGINEER, to be placed directly below each overlap of FML that is to be seamed. This is to prevent any moisture build-up between the sheets to be welded.
8. Seaming will extend to the outside edge of panels to be placed in anchor trenches.
9. If required, a firm substratum should be provided by using a flat board, a conveyor belt, or similar hard surface directly under the seam overlap to achieve proper support.
10. No folds, wrinkles or "fish-mouths" shall be allowed within the seam area. Where wrinkles or folds occur, the material shall be cut, overlapped and an extrusion-weld shall be applied. All welds on completion of the work shall be tightly bonded and sealed. Do not cover FML at locations that have been repaired until test results with passing values are available.
11. After seaming is complete in a given area, FML edges in the anchor trench should be buried. Do not bury the FML edge in the anchor trench within 30 feet of an incomplete or unbounded field seam.
12. At the end of each day or installation segment, all unseamed edges shall be anchored by sand bags or other approved device. Sand bags shall weigh approximately 20 pounds and shall be placed no further apart than 20 foot spacing along the open end of the FML. Sand bags securing the FML on the side slopes should be connected by a rope fastened at the top of the slope by a temporary anchor. If high winds are expected, boards along the edge of unseamed panels, with weighted sand bags on top, should be used to anchor the FML on the bottom of the cell. Sand bags fastened by rope should be used to secure unseamed edges on the side slopes. Staples, U-shaped rods or other penetrating anchors shall not be used to secure the FML. The temporary anchoring of the FML is the responsibility of the CONTRACTOR. Any material damaged as the result of weather effects, shall be repaired or replaced at no cost to the COMPANY.

### **3.4 FML TESTING**

#### **A. General**

1. CONTRACTOR shall employ a Geosynthetic Quality Assurance Laboratory to conduct all laboratory testing required by these Specifications.
2. Samples of the field seams shall be taken and tested in accordance with ASTM D638 to ensure that tensile strength at yield and break, elongation at yield and break meet the minimum specifications. A quality control certificate shall be issued with the material.
3. The CONTRACTOR shall employ on-site physical non-destructive testing on all welds.
4. A quality control technician shall inspect each sheet and seam. Any area showing a defect shall be marked and repaired in accordance with the FML repair procedures presented in these Specifications.

- B. Trial Weld Testing. Trial weld testing shall be performed to verify welding equipment is operating properly. Trial weld testing shall be made each day prior to commencing field seaming and no welding equipment or welder shall be allowed to perform production welds until equipment and welders have successfully completed a trial weld test. Trial weld testing shall be completed in accordance with the following:

1. Make trial welds under the same surface and environmental conditions as the production welds, i.e., in contact with subgrade and similar ambient temperature.
2. Minimum of two trial weld tests per day, per welding apparatus, one made prior to the start of work and one completed at mid shift. Each seamer will make at least one trial weld test each day.
3. Cut four, one-inch wide by six-inch long test specimens from the trial weld and quantitatively test the specimens for peel adhesion and shear strength. Trial weld test specimens shall pass when the results are in compliance with the following minimum seam values:

Property	ASTM Procedure	Unit	Minimum Values
Peel Strength (fusion)	D6392	lb/in	75
Peel Strength (extrusion)	D6392	lb/in	72
Shear Strength	D6392	lb/in	90

4. The criteria for passing a peel test shall be conformance with all of the following:
    - a. Failure shall be by Film Tear Bond (FTB);
    - b. No greater than 10 percent of the seam width peels (separates) at any point;
    - c. Compliance with the specified minimum seam values for peel; and
    - d. The break shall be ductile and shall occur in the FML material itself, not through peel separation.
  5. The criteria for passing a shear test shall be conformance with all of the following:
    - a. Failure shall be by FTB; and
    - b. Compliance with the specified minimum seam values for shear.
  6. If a trial weld fails, the entire operation will be repeated. If the additional trial weld fails, the seaming apparatus or seamer will not be accepted and will not be used for seaming until the deficiencies are corrected and two consecutive successful full test seams are achieved. Trial weld failure is defined as failure of any one of the specimens tested in shear or peel.
  7. Successful trial weld samples shall be assigned a number and marked accordingly by the CONTRACTOR, who will also log the date, hour, ambient temperature, number of seaming unit, name of seamer and pass or fail description. The CONTRACTOR shall submit this data to the COMPANY following acceptance of the FML.
- C. Non-Destructive Testing. All field seams shall be tested by the CONTRACTOR continuously using non-destructive techniques. Requirements for non-destructive testing are as follows:
1. Single Weld Seams: CONTRACTOR shall maintain and use equipment and personnel at the site to perform continuous vacuum box testing on all single weld production seams or when the geometry of the weld makes pressure testing impractical. Vacuum testing shall be performed in accordance with ASTM D 5641.
  2. Double Weld Seams: CONTRACTOR shall maintain and use equipment and personnel to perform air pressure testing of all double weld seams. Air pressure testing shall be performed in accordance with ASTM D 5820.

D. Destructive Testing. Field seams shall be tested by the CONTRACTOR at specified intervals using destructive tests. Requirements for destructive testing are as follows:

1. Destructive testing will be performed on an average of every 1,500 linear feet of field seam. Test locations shall be approved by the ENGINEER.
2. Destructive test samples shall be 12 inches wide and of sufficient length to provide one sample to archive, one sample to the ENGINEER, and two samples to the CONTRACTOR for both field and laboratory testing.
3. Destructive testing shall be performed in accordance with ASTM D 6392, Standard Test Method for Determining the Integrity of Non-Reinforced Geomembrane Seams Produced Using Thermo-Fusion Methods. Testing requirements are as follows:
  - a. Each sample shall be large enough to test five specimens in peel and five specimens in shear.
  - b. The average values of each set of five specimens must comply with the material and seam requirements of this Specification and four of the five specimen tests must meet the material and seam requirements of this Specification for the seam to be considered a passing seam. If the average of the five specimens is adequate, but one of the specimens is failing, values for the failing specimen must be at least 80 percent of the specified values for the seam sample to pass.
  - c. A maximum of one non-FTB failure out of five tests is acceptable provided the non-FTB specimen meets strength requirements.
  - d. If unresolved discrepancies exist between Engineer's and CONTRACTOR's test results, the archived sample may be tested by the Engineer.
4. Test specimens shall pass when the results are in compliance with the following minimum seam values:

<b>Property</b>	<b>ASTM Procedure</b>	<b>Unit</b>	<b>Minimum Values</b>
Peel Strength (fusion)	D6392	lb/in	75
Peel Strength (extrusion)	D6392	lb/in	72
Shear Strength	D6392	lb/in	90

5. Failed Seam Procedures:
  - a. If the seam fails, INSTALLER shall follow one of two options:
    - i. Reconstruct the seam between any two passed test locations.
    - ii. Trace the weld to intermediate location at least 10 feet minimum or where the seam ends in both directions from the location of the failed test.
  - b. The next seam welded using the same welding device is required to obtain an additional sample, i.e., if one side of the seam is less than 10 feet long.
  - c. If sample passes, then the seam shall be reconstructed or capped between the test sample locations.
6. CONTRACTOR shall repair all holes in the FML resulting from destructive sampling and shall test the continuity of the repair in accordance with these Specifications.

### **3.5 FML REPAIR**

- A. Remove damaged FML and replace with acceptable FML materials if damage cannot be satisfactorily repaired.
- B. Repair any portion of unsatisfactory FML or seam area failing a destructive or non-destructive test.
- C. INSTALLER shall be responsible for repair of defective areas.
- D. Agreement upon the appropriate repair method shall be decided between ENGINEER and CONTRACTOR by using one of the following repair methods:
  - 1. Patching- Used to repair large holes, tears, undispersed raw materials and contamination by foreign matter.
  - 2. Abrading and Re-welding- Used to repair short section of a seam.
  - 3. Spot Welding- Used to repair pinholes or other minor, localized flaws or where FML thickness has been reduced.
  - 4. Capping- Used to repair long lengths of failed seams.
  - 5. Flap Welding- Used to extrusion weld the flap (excess outer portion) of a fusion weld in lieu of a full cap.
  - 6. Remove the unacceptable seam and replace with new material.
- E. The following procedures shall be followed when a repair method is used:
  - 1. All FML surfaces shall be clean and dry at the time of repair.
  - 2. Surfaces of the FML which are to be repaired by extrusion welds shall be lightly abraded to assure cleanliness.
  - 3. Extend patches or caps at least 6 inches for extrusion welds and 4 inches for wedge welds beyond the edge of the defect, and around all corners of patch material.
- F. Repair Verification. CONTRACTOR shall number and log each patch repair and shall non-destructively test each repair using methods specified in this Specification

### **3.6 PROTECTIVE SOIL PLACEMENT**

- A. Protective Soil shall be placed over the FML as specified in Section 02300 of these Specifications and as specified herein.
- B. When an FML is installed over a GCL, Protective Soil placement shall also comply with the requirements of Section 02410 of these specifications.

### **3.7 FML ACCEPTANCE**

- A. COMPANY will accept the FML installation when:
  - 1. The installation is complete as determined by the ENGINEER.
  - 2. All required submittals and documentation have been received and approved by ENGINEER.

3. Test reports verifying completion of all field seams and repairs are in accord with specified requirements.
4. CONTRACTOR provides ENGINEER with as-built record drawings of the instrument surveyed panel layout and seam locations with reference numbers for test locations.
5. Written certification documents have been received and approved by ENGINEER.

++END OF SECTION++

LUMINANT

## SECTION 02430

### GEOTEXTILE

#### PART 1 – GENERAL

##### 1.1 DESCRIPTION

- A. This section shall govern work associated with furnishing and installing geotextile including, but not limited to, layout, installation, and testing.

##### 1.2 REFERENCES

- A. American Society of Testing Materials (ASTM) Standards/Publications (Latest version):

D3776	Test Method for Mass per Unit Area (weight) of Woven Fabric
D3786	Test Method for Hydraulic Bursting Strength of Knitted Goods and Non-woven Fabrics
D3787	Test Method for Hydraulic Bursting Strength of Knitted Goods and Non-woven Fabrics, Diaphragm Bursting Strength Test
D4354	Standard Practice for Sampling Geosynthetics for Testing
D4355	Test Method for Deterioration of Geotextiles by Exposure to Light, Moisture and Heat in a Xenon Arc Type Apparatus
D4491	Test Method for Water Permeability of Geotextiles by Permittivity
D4533	Test Method for Trapezoid Tearing Strength of Geotextiles
D4595	Test Method for Tensile Properties by the Wide-width Strip Method
D4632	Test Method for Breaking Load and Elongation of Geotextiles (Grab Method)
D4751	Test Method for Determining Apparent Opening Size of Geotextile
D4833	Test Method for Index Puncture Resistance of Geotextiles, Geomembranes, and Related Products
D5199	Test Method for Measuring Nominal Thickness of Geotextiles and Geomembranes

##### 1.3 SUBMITTALS

- A. At least 14 days prior to installation of the geotextile, CONTRACTOR shall submit for approval the following information:
1. Manufacturer's Literature. Submit manufacturer's literature for proposed geotextile, including catalog cut sheets, material samples and, written instructions for delivery, storage, handling, installation, seaming, and repair.
  2. Manufacturer Certification. Written certification from the manufacturer that the geotextile complies with the requirements of these specifications and is appropriate for the intended application.



## PART 2 - PRODUCTS

### 2.1 GEOTEXTILE

- A. Geotextile shall be non-woven, continuous or staple filament, needle-punched polypropylene or polyester suitable for AASHTO M-288 Class 2 applications. Yarn shall be oriented into a stable network that maintains its structure during handling, installation, and long-term service.
- B. Geotextile shall be uniform in color, density, and other physical properties and free of foreign inclusions or other defects.
- C. Geotextile shall be nominal 8 oz per square yard and shall conform to the following minimum average roll values for the properties listed:

Property	ASTM	Unit	Minimum Values
Mass per Unit Area	D5261	oz/yd <sup>2</sup>	8
Grab Tensile Strength	D4632	lb	220
Grab Elongation	D4632	%	50
CBR Puncture Strength	D6241	lb	575
Trapezoid Tear Strength	D4533	lb	90
Apparent Opening Size	D4751	US Sieve	80
Permittivity	D4491	sec <sup>-1</sup>	1.3
Water Flow Rate	D4491	gpm/ft <sup>2</sup>	95
UV Resistance	D4355	% Retained	70

## PART 3 - EXECUTION

### 3.1 DELIVERY, STORAGE and HANDLING

- A. Comply with the manufacturer's recommendations regarding product handling and protection.
- B. Deliver products to the job site in their manufacturer's original packaging, with labels intact and legible.
- C. Maintain packaged materials with seals unbroken and labels intact until time of use. Maintain in a manner that keeps product clean, dry and free of damage. Promptly remove damaged or unsuitable products from the job site and promptly replace with products meeting the required specifications.
- D. Comply with manufacturer's recommendations when hauling, unloading, deploying, and installing geotextile. Inspect for defects before installing.

### 3.2 GEOTEXTILE INSTALLATION

- A. Extend geotextile into anchor trenches as shown in the Drawings. Roll geotextile down the slope in such a manner as to maintain tension to preclude folds and wrinkles. Remove any folds or wrinkles by hand.
- B. Ballast geotextile during deployment. Remove ballast immediately prior to covering geotextile with succeeding construction layer.
- C. During installation, do not entrap rocks, dust, or moisture that could damage geotextile or cause clogging.
- D. Schedule deployment activities so geotextile is exposed to direct sunlight for no more than 5 days, unless geotextile is ultraviolet-light stabilized.

- E. Overlap geotextile 2 feet minimum at all seams.
- F. Inspect geotextile and repair holes or tears. Patch using the same geotextile, with minimum overlap of 2 feet in all directions.

++END OF SECTION++

LUMINANT

## SECTION 02440

### GECOMPOSITE DRAINAGE LAYER

#### PART 1 – GENERAL

##### 1.1 DESCRIPTION

- A. This section shall govern work associated with furnishing and installing geocomposite drainage layer including, but not limited to, layout, installation, and testing.

##### 1.2 REFERENCES

- A. American Society for Testing and Materials (ASTM)
- |       |   |
|-------|---|
| D1238 | Standard Test Method for Melt Flow Rates of Thermoplastics by Extrusion Plastometer   |
| D1505 | Standard Test Method for Density of Plastics by the Density-Gradient Technique  |
| D4218 | Standard Test Method for Determination of Carbon Black Content in Polyethylene Compounds by the Muffle Furnace Technique D 1603-94 Standard Test Method for Carbon Black in Olefin Plastics   |
| D4355 | Standard Test Method for Deterioration of Geotextiles by Exposure to Light, Moisture and Heat in a Xenon Arc Type Apparatus   |
| D4491 | Standard Test Method for Water Permeability of Geotextiles by Permittivity  |
| D4533 | Standard Test Method for Trapezoid Tearing Strength of Geotextiles  |
| D4716 | Standard Test Method for Determining the (In-Plane) Flow Rate Per Unit Width and Hydraulic Transmissivity of a Geosynthetic Using a Constant Head   |
| D4751 | Standard Test Method for Determining Apparent Opening Size of a Geotextile  |
| D6241 | Standard Test Method for the Static Puncture Strength of Geotextiles and Geotextile- Related Products Using a 50-mm Probe D 4833-88 (1996) Standard Test Method for Index Puncture Resistance of Geotextiles, Geomembranes and Related Products |
| D5261 | Standard Test Method for Measuring the Mass Per Unit Area of Geotextiles  |
| D7005 | Determining the Bond Strength (Ply-Adhesion) of Geocomposites   |
| D7179 | Standard Test Method for Determining Geonet Breaking Force  |
- B. Environmental Protection Agency (EPA)
- Daniel, D.E. and R.M. Koerner, (1993), Technical Guidance Document: Quality Assurance and Quality Control for Waste Containment Facilities, EPA/600/R-93/182.

##### 1.3 DEFINITIONS

- A. COMPANY - The individual or firm responsible for the design and preparation of the project's Contract Drawings and Specifications.
- B. Geocomposite Manufacturer (MANUFACTURER) - The party responsible for manufacturing the geocomposite rolls.

- C. Geosynthetic Quality Assurance Laboratory (TESTING LABORATORY) – Provided by CONTRACTOR, party that's independent from the MANUFACTURER and INSTALLER, responsible for conducting laboratory tests on samples of geosynthetics obtained at the site or during manufacturing.
- D. INSTALLER- Party responsible for field handling, transporting, storing and deploying the geocomposite.
- E. Lot- A quantity of resin (usually the capacity of one rail car) used to manufacture polyethylene geocomposite rolls. The finished rolls will be identified by a roll number traceable to the resin lot.

#### **1.4 QUALIFICATIONS**

##### **A. MANUFACTURER**

1. MANUFACTURER shall have manufactured a minimum of 10,000,000 square feet of polyethylene geocomposite material.

##### **B. INSTALLER**

1. INSTALLER shall have installed a minimum of 1 million square feet of geocomposite in the last year.
2. INSTALLER shall have worked in a similar capacity on at least 5 projects similar in complexity to the project described in the contract documents.
3. The Installation Supervisor shall have worked in a similar capacity on projects similar in size and complexity to the project described in the Contract Documents.

#### **1.5 SUBMITTALS**

##### **A. At least 14 days prior to installation of the geocomposite, CONTRACTOR shall submit for approval the following information:**

1. Manufacturer's Literature. Submit manufacturer's literature for proposed geocomposite, including catalog cut sheets, material samples and, written instructions for delivery, storage, handling, installation, seaming, and repair.
2. Manufacturer Certification. Written certification from the manufacturer that the geocomposite complies with the requirements of these specifications and is appropriate for the intended application.

#### **1.6 MATERIAL LABELING, DELIVERY, STORAGE AND HANDLING**

##### **A. Labeling - Each roll delivered to the site shall be wrapped and labeled by the MANUFACTURER. The label will identify:**

1. manufacturer's name
2. product identification
3. length
4. width
5. roll number

##### **B. Delivery - Rolls will be prepared to ship by appropriate means to prevent damage to the material and to facilitate off-loading.**

- C. Storage - The on-site storage location provided by the CONTRACTOR to protect the geonet from abrasions, excessive dirt and moisture shall have the following characteristics:
1. level (no wooden pallets)
  2. smooth
  3. dry
  4. protected from theft and vandalism
  5. adjacent to the area being lined
- D. Handling
1. The CONTRACTOR and INSTALLER shall handle all rolls in such a manner to ensure they are not damaged in any way.
  2. The INSTALLER shall take any necessary precautions to prevent damage to underlying layers during placement of the drainage material.

## 1.7 WARRANTY

- A. Material shall include one-year warranty against defects.
- B. Installation shall be warranted against defects in workmanship for a period of 1-year from the date of geocomposite completion.

## PART 2 - PRODUCTS

### 2.1 GEOCOMPOSITE PRODUCT STANDARD

- A. Geocomposite shall be 275-mil FabriNet Geocomposite Double-sided with 8 oz geotextile as manufactured by GSE, or approved equal.
- B. Geocomposite shall be manufactured by extruding two crossing strands to form a bi-planar drainage net structure with a non-woven geotextile bonded to one or both sides.
- C. Geocomposite shall have properties that meet or exceed the values listed as follows:

#### 1. Geocomposite

Property	ASTM	Frequency	Unit	Minimum Values
Transmissivity	D4716	1/540,000 ft2	gal/min/ft	3.4
Ply Adhesion	D7005	1/50,000 ft2	lb/in	1.0

#### 2. Geonet

Property	ASTM	Frequency	Unit	Minimum Values
Core Thickness	D5199	1/50,000 ft2	mil	275
Transmissivity	D4716	1/50,000 ft2	gal/min/ft	29
Density	D1505	1/50,000 ft2	g/cm3	0.94
Tensile Strength	D7179	1/50,000 ft2	lb/in	65
Carbon Black Content	D4218	1/50,000 ft2	%	2.0

#### 3. Geotextile

Property	ASTM	Frequency	Unit	Minimum Values
Mass per Unit Area	D5261	1/90,000 ft2	oz/yd2	8
Grab Tensile Strength	D4632	1/90,000 ft2	lb	220

Grab Elongation	D4632	1/90,000 ft2	%	50
CBR Puncture Strength	D6241	1/90,000 ft2	lb	575
Trapezoid Tear Strength	D4533	1/90,000 ft2	lb	90
Apparent Opening Size	D4751	1/540,000 ft2	US Sieve	80
Permittivity	D4491	1/540,000 ft2	sec <sup>-1</sup>	1.3
Water Flow Rate	D4491	1/540,000 ft2	gpm/ft2	95
UV Resistance	D4355	Per Formulation	% Retained	70

D. Resin

1. Resin shall be new first quality, compounded polyethylene resin.
2. Natural resin (without carbon black) shall meet the following additional minimum requirements:

Property	ASTM Test Method	Value
Density (g/cm <sup>3</sup> )	D1505	>0.932
Melt Flow Index (g/10 min)	D1238	< 1.0

**2.2 MANUFACTURING QUALITY CONTROL**

1. Geocomposite shall be manufactured in accordance with the Manufacturer's Quality Control Plan.

**PART 3 - EXECUTION**

**3.1 DELIVERY, STORAGE and HANDLING**

- A. Comply with the manufacturer's recommendations regarding product handling and protection.
- B. Deliver products to the job site in their manufacturer's original packaging, with labels intact and legible.
- C. Maintain packaged materials with seals unbroken and labels intact until time of use. Maintain in a manner that keeps product clean, dry and free of damage. Promptly remove damaged or unsuitable products from the job site and promptly replace with products meeting the required specifications.
- D. Comply with manufacturer's recommendations when hauling, unloading, deploying, and installing geotextile. Inspect for defects before installing.

**3.2 FAMILIARIZATION**

- A. Inspection
  1. Prior to implementing any of the work in the Section to be lined, the INSTALLER shall carefully inspect and approve the areas to receive the geocomposite.
  2. If INSTALLER has any concerns regarding the areas to receive geocomposite, he shall immediately notify COMPANY.

**3.3 INSTALLATION**

- A. The geocomposite roll should be installed in the direction of the slope and in the intended

direction of flow unless otherwise specified by the COMPANY.

- B. If the project contains long, steep slopes, special care should be taken so that only full length rolls are used at the top of the slope.
- C. In the presence of wind, all geocomposites shall be weighted down with sandbags or the equivalent. Such sandbags shall be used during placement and remain until replaced with cover material.
- D. The geocomposite shall be properly anchored to resist sliding. Anchor trench compacting equipment shall not come into direct contact with the geocomposite.
- E. In applying fill material, no equipment can drive directly across the geocomposite. The specified fill material shall be placed and spread utilizing vehicles with a low ground pressure.
- F. The cover soil shall be placed in the geocomposite in a manner that prevents damage to the geocomposite. Placement of the cover soil shall proceed immediately following the placement and inspection of the geocomposite.

### **3.4 SEAMS AND OVERLAPS**

- A. Each component of the geocomposite will be secured or seamed to the like component at overlaps.
- B. Geonet Components
  - 1. Adjacent edges of the geonet along the length of the geocomposite roll shall be placed with the edges of each geonet butted against each other.
  - 2. The overlaps shall be joined by tying the geonet structure with cable ties. These ties shall be spaced every 5 feet along the roll length.
  - 3. Adjoining geocomposite rolls (end to end) across the roll width should be shingled down in the direction of the slope, with the geonet portion of the top overlapping the geonet portion of the bottom geocomposite a minimum of 12 inches across the roll width.
  - 4. The geonet portion should be tied every 6 inches in the anchor trench or as specified by the COMPANY.

### **3.5 REPAIR**

- A. Prior to covering the deployed geocomposite, each roll shall be inspected for damage resulting from construction.
- B. Any rips, tears or damaged areas on the deployed geocomposite shall be removed and patched. The patch shall be secured to the original geonet by tying every 6 inches with the approved tying devices. If the area to be repaired is more than 50 percent of the width of the panel, the damaged area shall be cut out and the two portions of the geonet shall be cut out and the two portions of the geonet shall be joined in accordance with 3.4 above.

++END OF SECTION++

## SECTION 02450

### GEOCELLS

#### PART 1 – GENERAL

##### 1.1 DESCRIPTION

- A. This section shall govern work associated with furnishing and installing geocells (cellular confinement system) including, but not limited to, layout, installation, and testing.

##### 1.2 REFERENCES

- A. American Society for Testing and Materials (ASTM)
- |       |  |
|-------|--|
| D1505 | Standard Test Method for Density of Plastics by the Density-Gradient Technique   |
| D1603 | Standard Test Method for Carbon Black In Olefin Plastics   |
| D1693 | Standard Test Method for Environmental Stress-Cracking of Ethylene Plastics  |
| D5199 | Standard Test Method for Measuring the Nominal Thickness of Geosynthetics  |
| D5397 | Standard Test Method for Evaluation of Stress Crack Resistance of Polyolefin Geomembranes Using Notched Constant Tensile Load Test |
- B. US Army Corps of COMPANYS (USACE)
- Technical Report GL-86-19, Appendix A.

##### 1.4 QUALIFICATIONS

- A. Geocell Manufacturer's Field Representative shall have worked in a similar capacity on at least 5 geocell projects similar in complexity to the project described in the contract documents.
- B. Geocell Installer shall have worked in a similar capacity on at least 5 geocell projects similar in complexity to the project described in the contract documents.

##### 1.5 SUBMITTALS

- A. At least 14 days prior to installation of the geocells, CONTRACTOR shall submit for approval the following information:
1. Manufacturer's Literature. Submit manufacturer's literature for proposed geocells, including catalog cut sheets, material samples and, written instructions for delivery, storage, handling, installation, seaming, and repair.
  2. Manufacturer Certification. Written certification from the manufacturer that the geocells comply with the requirements of these specifications and is appropriate for the intended application.

##### 1.6 WARRANTY

- A. Material shall include one-year warranty against defects.
- B. Installation shall be warranted against defects in workmanship for a period of 1-year from the date of geocell completion.



**PART 2 - PRODUCTS**

**2.1 GEOCELL PRODUCT STANDARD**

A. Geocells shall be black Terracell 140 perforated, textured high-density polyethylene (HDPE) geocell as manufactured by Hanes Geo Components, or approved equal.

B. Geocells shall be manufactured to meet the values listed as follows:

Property	Values
Cell Depth	4 in
Nominal Expanded Cell Size	10.2 in X 8.8 in
Nominal Expanded Cell Area	44.8 in
Nominal Expanded Section (L X W)	21.4 ft X 8.4 ft
Cells per Section (L X W)	29 cells X 10 cells
Nominal Expanded Section Area	180 sf
Weld Spacing	14 in

C. Geocells shall be constructed using virgin, non-thermally degraded HDPE with material properties that meet or exceed the following values:

Property	ASTM	Unit	Minimum Values
Polymer Density	D1505	g/cm3	0.935-0.965
Environmental Stress Crack Resistance	D5397	hours	>400
Environmental Stress Crack Resistance	D1693	hours	>6000
Minimum Carbon Black Content	D1603	%	1.5
Nominal Sheet Thickness	D5199	mil	60 (+10%, -5%)
Seam Peel Strength	USACE	lb	320

D. Geocell weld joints shall have a Seam Hang Strength able to support a load of 160 pounds for 30 days minimum or for 7 days minimum while undergoing temperature change from 74 degrees F to 130 degrees F on 1-hour cycle.

E. The HDPE strips used to construct the Geocell shall be textured with diamond shaped indentations. The rhomboidal indentations shall have a surface density of 140 to 200 per in<sup>2</sup>.

F. Geocells shall be perforated with 10 mm diameter holes spaced at 16.6 mm on center. The holes shall be placed in horizontal rows staggered 8.3 mm on relative to hole centers.

G. Geocell section length shall be in accordance with manufacturer recommendations for intended application.

## **2.2 ACCESSORIES**

### **A. J-Hooks:**

1. J-Hooks shall be uncoated steel reinforcing bars as follows:
  - a. Diameter: 0.5 inch
  - b. Length: 12 inches minimum.
  - c. Hook: 180-degree bend

## **2.3 INFILL MATERIAL**

- A. Infill Material shall be concrete. Concrete shall at a minimum be Class A, 3,000-psi concrete with three-quarter inch diameter aggregate.

## **PART 3 - EXECUTION**

### **3.1 DELIVERY, STORAGE and HANDLING**

- A. Comply with the Manufacturer's recommendations regarding product handling and protection.
- B. Deliver products to the job site in their manufacturer's original packaging, with labels intact and legible.
- C. Maintain packaged materials with seals unbroken and labels intact until time of use. Maintain in a manner that keeps product clean, dry and free of damage. Promptly remove damaged or unsuitable products from the job site and promptly replace with products meeting the required specifications.
- D. Comply with Manufacturer's recommendations when hauling, unloading, deploying, and installing geotextile. Inspect for defects before installing.

### **3.2 FAMILIARIZATION**

- A. Inspection
  3. Prior to beginning geocell installation, Geocell Installer and Geocell Manufacturer's Field Representative shall carefully inspect and approve the area to receive geocells.
  4. If Geocell Installer or Geocell Manufacturer's Field Representative have any concerns regarding the proposed geocell area, they shall immediately notify COMPANY.

### **3.3 PREPARATION**

- A. Prepare site by removing vegetative cover, debris, and unacceptable soils from area where geocells will be installed.
- B. Replace removed soils with acceptable materials.

### **3.4 INSTALLATION**

- A. Install geocells in accordance with manufacturer's instructions at locations indicated on the drawings.
- B. Anchor geocell sections as necessary to resist sliding due to gravitational forces and sheet flow. The upper edge of the geocell shall be buried in an anchor trench as recommended by the Manufacturer and shown on the Drawings. Geocells shall also be anchored using J-Hooks in

accordance with manufacturer recommendations.

- C. Ensure top edges of adjoining cell walls are flush with each other and in proper alignment.
- D. Geocells shall be infilled with concrete. Deliver infill material to geocells from top of slope or channel to bottom in accordance with manufacturer's instructions.
- E. Limit drop height of infill material to a maximum of 3 feet to prevent damage to geocells.
- F. Manually rake and machine finish concrete infill material.

++END OF SECTION++

LUMINANT

**APPENDIX B**  
**HELP MODEL OUTPUT**

LUMIVANT

```

*****
*****
**                                     **
**                                     **
**HYDROLOGIC EVALUATION OF LANDFILL PERFORMANCE **
**  HELP MODEL VERSION 3.07 (1 November 1997) **
**  DEVELOPED BY ENVIRONMENTAL LABORATORY **
**  USAE WATERWAYS EXPERIMENT STATION **
**FOR USEPA RISK REDUCTION ENGINEERING LABORATORY**
**                                     **
**                                     **
*****
*****

```

```

PRECIPITATION DATA FILE:  C:\WHI\VHELP22\data\P2118.VHP\_weather1.dat
TEMPERATURE DATA FILE:   C:\WHI\VHELP22\data\P2118.VHP\_weather2.dat
SOLAR RADIATION DATA FILE: C:\WHI\VHELP22\data\P2118.VHP\_weather3.dat
EVAPOTRANSPIRATION DATA:  C:\WHI\VHELP22\data\P2118.VHP\_weather4.dat
SOIL AND DESIGN DATA FILE: C:\WHI\VHELP22\data\P2118.VHP\_387503.inp
OUTPUT DATA FILE:        C:\WHI\VHELP22\data\P2118.VHP\O_387503.prt

```

TIME: 13:52 DATE: 9/ 7/2016

```

*****
TITLE:  BAP Option 1 Compacted Clay Cap
*****

```

NOTE: INITIAL MOISTURE CONTENT OF THE LAYERS AND SNOW WATER WERE COMPUTED AS NEARLY STEADY-STATE VALUES BY THE PROGRAM.

LAYER 1  
-----

```

TYPE 1 - VERTICAL PERCOLATION LAYER
MATERIAL TEXTURE NUMBER 6
THICKNESS           = 45.72 CM
POROSITY            = 0.4530 VOL/VOL
FIELD CAPACITY     = 0.1900 VOL/VOL
WILTING POINT      = 0.0850 VOL/VOL
INITIAL SOIL WATER CONTENT = 0.4401 VOL/VOL
EFFECTIVE SAT. HYD. COND. = 0.720001612800E-03 CM/SEC
NOTE: SATURATED HYDRAULIC CONDUCTIVITY IS MULTIPLIED BY 5.00
FOR ROOT CHANNELS IN TOP HALF OF EVAPORATIVE ZONE.

```

LAYER 2  
-----

```

TYPE 3 - BARRIER SOIL LINER
MATERIAL TEXTURE NUMBER 29
THICKNESS           = 91.44 CM
POROSITY            = 0.4510 VOL/VOL
FIELD CAPACITY     = 0.4190 VOL/VOL
WILTING POINT      = 0.3320 VOL/VOL
INITIAL SOIL WATER CONTENT = 0.4510 VOL/VOL
EFFECTIVE SAT. HYD. COND. = 0.100000000000E-06 CM/SEC

```

GENERAL DESIGN AND EVAPORATIVE ZONE DATA  
-----

NOTE: SCS RUNOFF CURVE NUMBER WAS COMPUTED FROM DEFAULT SOIL DATA BASE USING SOIL TEXTURE # 6 WITH A

FAIR STAND OF GRASS, A SURFACE SLOPE OF 3.0%  
AND A SLOPE LENGTH OF 88. METERS.

SCS RUNOFF CURVE NUMBER = 69.52  
 FRACTION OF AREA ALLOWING RUNOFF = 100.0 PERCENT  
 AREA PROJECTED ON HORIZONTAL PLANE = 6.6773 HECTARES  
 EVAPORATIVE ZONE DEPTH = 25.4 CM  
 INITIAL WATER IN EVAPORATIVE ZONE = 10.917 CM  
 UPPER LIMIT OF EVAPORATIVE STORAGE = 11.506 CM  
 LOWER LIMIT OF EVAPORATIVE STORAGE = 2.159 CM  
 INITIAL SNOW WATER = 0.000 CM  
 INITIAL WATER IN LAYER MATERIALS = 61.361 CM  
 TOTAL INITIAL WATER = 61.361 CM  
 TOTAL SUBSURFACE INFLOW = 0.00 MM/YR

EVAPOTRANSPIRATION AND WEATHER DATA  
 -----

NOTE: EVAPOTRANSPIRATION DATA WAS OBTAINED FROM  
 Shreveport/MOSES LA

STATION LATITUDE = 32.47 DEGREES  
 MAXIMUM LEAF AREA INDEX = 4.50  
 START OF GROWING SEASON (JULIAN DATE) = 58  
 END OF GROWING SEASON (JULIAN DATE) = 331  
 EVAPORATIVE ZONE DEPTH = 10.0 INCHES  
 AVERAGE ANNUAL WIND SPEED = 8.60 MPH  
 AVERAGE 1ST QUARTER RELATIVE HUMIDITY = 70.00 %  
 AVERAGE 2ND QUARTER RELATIVE HUMIDITY = 72.00 %  
 AVERAGE 3RD QUARTER RELATIVE HUMIDITY = 72.00 %  
 AVERAGE 4TH QUARTER RELATIVE HUMIDITY = 72.00 %

NOTE: PRECIPITATION DATA WAS SYNTHETICALLY GENERATED USING  
 COEFFICIENTS FOR Shreveport/MOSES LA

NORMAL MEAN MONTHLY PRECIPITATION (INCHES)

JAN/JUL	FEB/AUG	MAR/SEP	APR/OCT	MAY/NOV	JUN/DEC
4.02	3.46	3.77	4.71	4.70	3.54
3.56	2.52	3.29	2.63	3.77	3.87

NOTE: TEMPERATURE DATA WAS SYNTHETICALLY GENERATED USING  
 COEFFICIENTS FOR Shreveport/MOSES LA

NORMAL MEAN MONTHLY TEMPERATURE (DEGREES FAHRENHEIT)

JAN/JUL	FEB/AUG	MAR/SEP	APR/OCT	MAY/NOV	JUN/DEC
46.00	49.80	57.00	65.70	73.00	79.80
82.90	82.40	77.10	66.70	55.70	48.70

NOTE: SOLAR RADIATION DATA WAS SYNTHETICALLY GENERATED USING  
 COEFFICIENTS FOR Shreveport/MOSES LA  
 AND STATION LATITUDE = 32.98 DEGREES

\*\*\*\*\*

AVERAGE MONTHLY VALUES IN INCHES FOR YEARS 1 THROUGH 30

	JAN/JUL	FEB/AUG	MAR/SEP	APR/OCT	MAY/NOV	JUN/DEC
<b>PRECIPITATION</b>						
TOTALS	3.60 3.53	2.99 2.17	3.85 3.08	4.96 2.64	4.51 3.69	3.71 3.58
STD. DEVIATIONS	2.46 1.79	1.49 1.84	1.64 1.72	2.11 1.45	2.06 1.20	2.37 2.26
<b>RUNOFF</b>						
TOTALS	1.981 0.084	1.056 0.001	0.840 0.094	0.823 0.123	0.354 0.704	0.212 1.901
STD. DEVIATIONS	2.255 0.413	1.146 0.002	1.162 0.307	1.016 0.453	0.853 1.045	0.791 2.059
<b>EVAPOTRANSPIRATION</b>						
TOTALS	1.669 3.461	2.113 2.097	3.146 2.482	4.857 1.660	4.898 1.061	3.798 1.251
STD. DEVIATIONS	0.173 1.629	0.294 1.548	0.584 1.240	0.652 0.831	1.404 0.201	2.181 0.201
<b>PERCOLATION/LEAKAGE THROUGH LAYER 2</b>						
TOTALS	0.1536 0.1299	0.1380 0.1285	0.1490 0.1247	0.1404 0.1323	0.1352 0.1391	0.1275 0.1534
STD. DEVIATIONS	0.0033 0.0038	0.0043 0.0027	0.0036 0.0045	0.0048 0.0070	0.0056 0.0110	0.0042 0.0057

AVERAGES OF MONTHLY AVERAGED DAILY HEADS (INCHES)

<b>DAILY AVERAGE HEAD ON TOP OF LAYER 2</b>						
AVERAGES	16.4313 8.3510	15.7181 7.8704	14.8547 7.9926	13.5184 9.1784	10.1434 13.0639	8.9699 16.3823
STD. DEVIATIONS	1.1139 1.2863	1.3280 0.9192	1.2403 1.5933	1.7069 2.3741	1.9081 3.8976	1.4953 1.9401

AVERAGE ANNUAL TOTALS & (STD. DEVIATIONS) FOR YEARS 1 THROUGH 30

	INCHES	CU. FEET	PERCENT
PRECIPITATION	42.31 (7.468)	2534301.9	100.00
RUNOFF	8.175 (4.7872)	489613.50	19.319
EVAPOTRANSPIRATION	32.492 (4.3711)	1946053.64	76.789
PERCOLATION/LEAKAGE THROUGH LAYER 2	1.65145 (0.02647)	98911.363	3.90290
AVERAGE HEAD ON TOP OF LAYER 2	11.873 (0.762)		
CHANGE IN WATER STORAGE	-0.005 (0.5407)	-276.60	-0.011

PEAK DAILY VALUES FOR YEARS 1 THROUGH 30 and their dates (DDDDYYYY)

	(INCHES)	(CU. FT.)	
PRECIPITATION	4.10	245564.14760	1980021
RUNOFF	3.751	224683.92928	130016
PERCOLATION/LEAKAGE THROUGH LAYER 2	0.005102	305.59328	3570001
AVERAGE HEAD ON TOP OF LAYER 2	18.000		
SNOW WATER	2.84	170129.5440	130002
MAXIMUM VEG. SOIL WATER (VOL/VOL)	0.4530		
MINIMUM VEG. SOIL WATER (VOL/VOL)	0.0850		

\*\*\*\*\*

\*\*\*\*\*

FINAL WATER STORAGE AT END OF YEAR 30

LAYER	(INCHES)	(VOL/VOL)
1	7.7833	0.4324
2	16.2360	0.4510
SNOW WATER	0.000	

\*\*\*\*\*

\*\*\*\*\*

LUMINANT



```

*****
*****
**                                     **
**                                     **
** HYDROLOGIC EVALUATION OF LANDFILL PERFORMANCE **
** HELP MODEL VERSION 3.07 (1 November 1997) **
** DEVELOPED BY ENVIRONMENTAL LABORATORY **
** USAE WATERWAYS EXPERIMENT STATION **
**FOR USEPA RISK REDUCTION ENGINEERING LABORATORY**
**                                     **
**                                     **
*****
*****

```

```

PRECIPITATION DATA FILE: C:\WHI\VHELP22\data\P2118.VHP\_weather1.dat
TEMPERATURE DATA FILE: C:\WHI\VHELP22\data\P2118.VHP\_weather2.dat
SOLAR RADIATION DATA FILE: C:\WHI\VHELP22\data\P2118.VHP\_weather3.dat
EVAPOTRANSPIRATION DATA: C:\WHI\VHELP22\data\P2118.VHP\_weather4.dat
SOIL AND DESIGN DATA FILE: C:\WHI\VHELP22\data\P2118.VHP\_387376.inp
OUTPUT DATA FILE: C:\WHI\VHELP22\data\P2118.VHP\O_387376.prt

```

TIME: 14:20 DATE: 9/ 8/2016

```

*****
TITLE: BAP Option 2 LLDPE Cap
*****

```

NOTE: INITIAL MOISTURE CONTENT OF THE LAYERS AND SNOW WATER WERE COMPUTED AS NEARLY STEADY-STATE VALUES BY THE PROGRAM.

LAYER 1  
-----

TYPE 1 - VERTICAL PERCOLATION LAYER  
MATERIAL TEXTURE NUMBER 6

THICKNESS	=	45.42	CM
POROSITY	=	0.4530	VOL/VOL
FIELD CAPACITY	=	0.1900	VOL/VOL
WILTING POINT	=	0.0850	VOL/VOL
INITIAL SOIL WATER CONTENT	=	0.2280	VOL/VOL
EFFECTIVE SAT. HYD. COND.	=	0.720000000000E-03	CM/SEC

NOTE: SATURATED HYDRAULIC CONDUCTIVITY IS MULTIPLIED BY 5.00 FOR ROOT CHANNELS IN TOP HALF OF EVAPORATIVE ZONE.

LAYER 2  
-----

TYPE 2 - LATERAL DRAINAGE LAYER  
MATERIAL TEXTURE NUMBER 20

THICKNESS	=	0.50	CM
POROSITY	=	0.8500	VOL/VOL
FIELD CAPACITY	=	0.0100	VOL/VOL
WILTING POINT	=	0.0050	VOL/VOL
INITIAL SOIL WATER CONTENT	=	0.0733	VOL/VOL
EFFECTIVE SAT. HYD. COND.	=	10.0000000000	CM/SEC
SLOPE	=	3.00	PERCENT
DRAINAGE LENGTH	=	88.4	METERS

LAYER 3

-----

TYPE 4 - FLEXIBLE MEMBRANE LINER

MATERIAL TEXTURE NUMBER 36

THICKNESS = 0.10 CM  
POROSITY = 0.0000 VOL/VOL  
FIELD CAPACITY = 0.0000 VOL/VOL  
WILTING POINT = 0.0000 VOL/VOL  
INITIAL SOIL WATER CONTENT = 0.0000 VOL/VOL  
EFFECTIVE SAT. HYD. COND. = 0.400000000000E-12 CM/SEC  
FML PINHOLE DENSITY = 9.88 HOLES/HECTARE  
FML INSTALLATION DEFECTS = 9.88 HOLES/HECTARE  
FML PLACEMENT QUALITY = 3 - GOOD

LAYER 4

-----

TYPE 1 - VERTICAL PERCOLATION LAYER

MATERIAL TEXTURE NUMBER 30

THICKNESS = 609.60 CM  
POROSITY = 0.5410 VOL/VOL  
FIELD CAPACITY = 0.1870 VOL/VOL  
WILTING POINT = 0.0470 VOL/VOL  
INITIAL SOIL WATER CONTENT = 0.1870 VOL/VOL  
EFFECTIVE SAT. HYD. COND. = 0.500000000000E-04 CM/SEC

GENERAL DESIGN AND EVAPORATIVE ZONE DATA

-----

NOTE: SCS RUNOFF CURVE NUMBER WAS COMPUTED FROM DEFAULT  
SOIL DATA BASE USING SOIL TEXTURE # 6 WITH A  
GOOD STAND OF GRASS, A SURFACE SLOPE OF 3%  
AND A SLOPE LENGTH OF 88. METERS.

SCS RUNOFF CURVE NUMBER = 61.24  
FRACTION OF AREA ALLOWING RUNOFF = 100.0 PERCENT  
AREA PROJECTED ON HORIZONTAL PLANE = 6.6773 HECTARES  
EVAPORATIVE ZONE DEPTH = 25.4 CM  
INITIAL WATER IN EVAPORATIVE ZONE = 5.145 CM  
UPPER LIMIT OF EVAPORATIVE STORAGE = 11.506 CM  
LOWER LIMIT OF EVAPORATIVE STORAGE = 2.159 CM  
INITIAL SNOW WATER = 0.000 CM  
INITIAL WATER IN LAYER MATERIALS = 124.389 CM  
TOTAL INITIAL WATER = 124.389 CM  
TOTAL SUBSURFACE INFLOW = 0.00 MM/YR

EVAPOTRANSPIRATION AND WEATHER DATA

-----

NOTE: EVAPOTRANSPIRATION DATA WAS OBTAINED FROM  
Shreveport/MOSES LA

STATION LATITUDE = 32.47 DEGREES  
MAXIMUM LEAF AREA INDEX = 4.50  
START OF GROWING SEASON (JULIAN DATE) = 58  
END OF GROWING SEASON (JULIAN DATE) = 331  
EVAPORATIVE ZONE DEPTH = 10.0 INCHES  
AVERAGE ANNUAL WIND SPEED = 8.60 MPH  
AVERAGE 1ST QUARTER RELATIVE HUMIDITY = 70.00 %  
AVERAGE 2ND QUARTER RELATIVE HUMIDITY = 72.00 %  
AVERAGE 3RD QUARTER RELATIVE HUMIDITY = 72.00 %  
AVERAGE 4TH QUARTER RELATIVE HUMIDITY = 72.00 %

NOTE: PRECIPITATION DATA WAS SYNTHETICALLY GENERATED USING  
COEFFICIENTS FOR Shreveport/MOSES LA

NORMAL MEAN MONTHLY PRECIPITATION (INCHES)

JAN/JUL	FEB/AUG	MAR/SEP	APR/OCT	MAY/NOV	JUN/DEC
4.02	3.46	3.77	4.71	4.70	3.54
3.56	2.52	3.29	2.63	3.77	3.87

NOTE: TEMPERATURE DATA WAS SYNTHETICALLY GENERATED USING COEFFICIENTS FOR Shreveport/MOSES LA

NORMAL MEAN MONTHLY TEMPERATURE (DEGREES FAHRENHEIT)

JAN/JUL	FEB/AUG	MAR/SEP	APR/OCT	MAY/NOV	JUN/DEC
46.00	49.80	57.00	65.70	73.00	79.80
82.90	82.40	77.10	66.70	55.70	48.70

NOTE: SOLAR RADIATION DATA WAS SYNTHETICALLY GENERATED USING COEFFICIENTS FOR Shreveport/MOSES LA AND STATION LATITUDE = 32.98 DEGREES

HEAD #1: AVERAGE HEAD ON TOP OF LAYER 3  
 DRAIN #1: LATERAL DRAINAGE FROM LAYER 2 (RECIRCULATION AND COLLECTION)  
 LEAK #1: PERCOLATION OR LEAKAGE THROUGH LAYER 3  
 LEAK #2: PERCOLATION OR LEAKAGE THROUGH LAYER 4

\*\*\*\*\*  
 \*\*\*\*\*

AVERAGE MONTHLY VALUES IN INCHES FOR YEARS 1 THROUGH 30

	JAN/JUL	FEB/AUG	MAR/SEP	APR/OCT	MAY/NOV	JUN/DEC
<b>PRECIPITATION</b>						
TOTALS	3.60 3.53	2.99 2.17	3.85 3.08	4.96 2.64	4.51 3.69	3.71 3.58
STD. DEVIATIONS	2.46 1.79	1.49 1.84	1.64 1.72	2.11 1.45	2.06 1.20	2.37 2.26
<b>RUNOFF</b>						
TOTALS	0.005 0.003	0.000 0.000	0.000 0.000	0.000 0.002	0.003 0.000	0.000 0.005
STD. DEVIATIONS	0.027 0.016	0.003 0.000	0.000 0.001	0.000 0.013	0.015 0.000	0.001 0.018
<b>EVAPOTRANSPIRATION</b>						
TOTALS	1.658 2.877	1.967 1.925	2.784 2.282	3.534 1.600	3.478 1.165	2.817 1.388
STD. DEVIATIONS	0.213 1.231	0.435 1.308	0.714 1.062	0.894 0.865	1.101 0.273	1.454 0.187
<b>LATERAL DRAINAGE COLLECTED FROM LAYER 2</b>						
TOTALS	2.2672 0.6921	1.3453 0.3643	1.1421 0.5044	1.4129 0.7596	1.3086 1.7662	1.0455 2.2296
STD. DEVIATIONS	2.1099 0.9132	1.0939 0.5666	1.1706 0.8250	1.0721 0.8782	1.3495 1.0664	1.2411 2.0708
<b>PERCOLATION/LEAKAGE THROUGH LAYER 3</b>						
TOTALS	0.0010 0.0003	0.0004 0.0001	0.0003 0.0002	0.0003 0.0003	0.0009 0.0003	0.0006 0.0012
STD. DEVIATIONS	0.0021 0.0008	0.0008 0.0002	0.0004 0.0007	0.0004 0.0012	0.0026 0.0004	0.0013 0.0022

PERCOLATION/LEAKAGE THROUGH LAYER 4

TOTALS	0.0010 0.0003	0.0005 0.0000	0.0004 0.0002	0.0003 0.0001	0.0005 0.0005	0.0010 0.0010
STD. DEVIATIONS	0.0017 0.0008	0.0009 0.0002	0.0007 0.0007	0.0005 0.0004	0.0009 0.0010	0.0025 0.0018

AVERAGES OF MONTHLY AVERAGED DAILY HEADS (INCHES)

DAILY AVERAGE HEAD ON TOP OF LAYER 3

AVERAGES	0.0904 0.0239	0.0403 0.0041	0.0218 0.0226	0.0270 0.0286	0.0869 0.0229	0.0577 0.1176
STD. DEVIATIONS	0.2134 0.0793	0.0862 0.0139	0.0379 0.0686	0.0379 0.1218	0.2646 0.0376	0.1367 0.2149

\*\*\*\*\*

AVERAGE ANNUAL TOTALS & (STD. DEVIATIONS) FOR YEARS 1 THROUGH 30

	INCHES	CU. FEET	PERCENT
PRECIPITATION	42.31 (7.468)	2534301.9	100.00
RUNOFF	0.019 (0.0405)	1163.61	0.046
EVAPOTRANSPIRATION	27.476 (3.4239)	1645617.12	64.934
LATERAL DRAINAGE COLLECTED FROM LAYER 2	14.83760 (5.25609)	888678.407	35.06600
PERCOLATION/LEAKAGE THROUGH LAYER 3	0.00583 (0.00488)	349.354	0.01379
AVERAGE HEAD ON TOP OF LAYER 3	0.045 (0.041)		
PERCOLATION/LEAKAGE THROUGH LAYER 4	0.00584 (0.00472)	349.664	0.01380
CHANGE IN WATER STORAGE	-0.025 (0.9475)	-1506.90	-0.059

\*\*\*\*\*

PEAK DAILY VALUES FOR YEARS 1 THROUGH 30 and their dates (DDDDYYYY)

	(INCHES)	(CU. FT.)	
PRECIPITATION	4.10	245564.14760	1980021
RUNOFF	0.147	8790.10607	130016
DRAINAGE COLLECTED FROM LAYER 2	1.16392	69711.28635	1380030
PERCOLATION/LEAKAGE THROUGH LAYER 3	0.004868	291.58372	1380030
AVERAGE HEAD ON TOP OF LAYER 3	15.611		
MAXIMUM HEAD ON TOP OF LAYER 3	22.275		
LOCATION OF MAXIMUM HEAD IN LAYER 2 (DISTANCE FROM DRAIN)	82.9 FEET		
PERCOLATION/LEAKAGE THROUGH LAYER 4	0.001383	82.85068	1620030
SNOW WATER	2.84	170129.5440	130002
MAXIMUM VEG. SOIL WATER (VOL/VOL)	0.4102		
MINIMUM VEG. SOIL WATER (VOL/VOL)	0.0850		

\*\*\* Maximum heads are computed using McEnroe's equations. \*\*\*

Reference: Maximum Saturated Depth over Landfill Liner  
by Bruce M. McEnroe, University of Kansas  
ASCE Journal of Environmental Engineering  
Vol. 119, No. 2, March 1993, pp. 262-270.

\*\*\*\*\*  
\*\*\*\*\*

FINAL WATER STORAGE AT END OF YEAR 30

LAYER	(INCHES)	(VOL/VOL)
1	3.3335	0.1864
2	0.0041	0.0206
3	0.0000	0.0000
4	44.8798	0.1870
SNOW WATER	0.000	

\*\*\*\*\*  
\*\*\*\*\*

LUMINANT

LUMIVANT

**APPENDIX C**

**SLIDE 7.0 – CAP/COVER SYSTEM SLOPE STABILITY MODEL OUTPUT**

September 30, 2016

Mr. Pat Behling  
Pastor, Behling & Wheeler, LLC  
2201 Double Creek Dr., Suite 4004  
Round Rock, TX 78664

**Re: Evaluation of Landfill Cap Slope Stability, Bottom Ash Ponds – Monticello Steam Electric Station, Titus County, Texas**

Dear Mr. Behling:

As requested by Pastor, Behling & Wheeler, LLC (PBW), Bullock, Bennett & Associates, LLC (BBA) has completed evaluation of slope-stability of the proposed cap for the Bottom Ash Ponds ash disposal facility at the Monticello Steam Electric Station located in Titus County, Texas. This analysis is based on the most recent preliminary design drawings dated August 2016, provided to BBA by PBW. No site specific geotechnical data was provided to BBA for this analysis, therefore, assumptions regarding typical soil properties and interface friction angles are made in this evaluation. It is recommended that site-specific soils and proposed synthetic materials be tested for engineering strength properties, and slope stability analysis using the on-site data and final design criteria be completed prior to construction activities.

The PBW design includes options for two different cap configurations, one including synthetic components and the other including use of a compacted clay liner system. Each system has been evaluated, as further discussed below.

Stability Analysis of Synthetic Cap Components

This stability analysis includes evaluation of veneer cover soils and synthetics on 10(H):1(V) slopes, assuming the following cap configuration (from bottom to top):

- Compacted clay subgrade;
- Textured (both sides) flexible membrane liner (FML);
- Double-sided (geotextile on both sides) geonet drainage layer; and,
- 1.5 foot-thick cover soils.

Soil slopes of 10(H):1(V) typically are stable and do not require slope stability analysis; however, when placed as a thin veneer over a barrier such as a synthetic liner/lateral drainage layer, stability can be compromised if resisting forces along the material interfaces are not sufficient to prevent sliding. To evaluate these conditions for the proposed cap system described above, slope stability analysis was completed using limit equilibrium and a finite slope model. As discussed in the attached analysis, veneer cover soil slope stability is very sensitive to the interface friction angle of materials, while typical variance of soil properties such as unit weight and internal friction angle have considerably less effect on the analysis. Given the sensitivity to interface friction angle, this parameter was varied for analysis, while a generally representative soil unit weight and internal friction angle were used.

A range of interface friction angles from 19 to 27 were used to capture the range associated with

proposed cap components, as shown in the attached Appendix Table 1 of the *Geosynthetics Research Institute, Direct Shear Database of Geosynthetic-to Geosynthetic and Geosynthetic-to-Soil Interfaces* (Koerner, Narejo, June 14, 2005). For conservative analysis, cohesion and adhesion values were assumed to be zero. A unit weight and internal friction angle of 115 pounds per cubic foot (pcf) and 15 degrees, respectively, were used for the soil and are generally representative of commonly available soils in Texas, including a wide range of silty, sandy, and lean to fat clays commonly used as cover soil.

Estimated factors of safety for this analysis range from approximately 3.5 to 5.2 for interface friction angles ranging from 19 to 27, respectively, with assumed cohesion and adhesion values of zero. See *Veneer Cover Soil Analysis of Synthetic Cap System* in Attachment 1 for calculations and further stated assumptions.

### Slope Stability Analysis of Alternate Clay Cap

The alternate clay cap system consists of the following, bottom to top:

- 1.0 foot-thick subgrade soil;
- 3.0 foot-thick compacted clay liner; and,
- 1.5 foot-thick protective cover/vegetative soil.

This slope stability analysis includes evaluation of the clay cap system using Rocscience Slide 7.0 software. The Simplified Bishop and Morgenstern-Price methods of analysis were conducted on over 400 potential failure surfaces, with the lowest calculated safety factor reported. Slope stability evaluation of the cap was performed for assumed short- and long-term conditions. Site specific geotechnical test data is not available; therefore assumptions regarding soil strength properties (for each soil layer) were made as follows:

#### Short-Term Conditions:

Cohesion, C: 500 pcf  
Friction Angle: 0

#### Long-Term Conditions:

Cohesion, C: 250 pcf  
Friction Angle: 15

The unit weight of soil was assumed to be 115 pcf for each soil layer. Coal combustion residual (ash) material underlies the cap. It is assumed the ash is non-cohesive, well drained and has been in place for a long time prior to capping. For ash the following properties were assumed for both short and long-term cap analysis:

Dry Unit Weight of Ash: 90 pcf  
Saturated Unit Weight of Ash: 95 pcf  
Cohesion, C: 0 pcf  
Friction Angle: 20 deg

The calculated factor of safety for the short- and long-term conditions were both determined to be approximately 3.9.



Mr. Pat Behling  
September 30, 2016  
Page 3 of 3

Please find attached the landfill cap slope stability analysis and supporting notes, assumptions, and documentation, and please feel free to contact me at (512) 355-9198 if you have any questions about this submittal, or if I can be of any further assistance.

Sincerely,

BBA, LLC



Dan Bullock, P.E.  
Principal Engineer

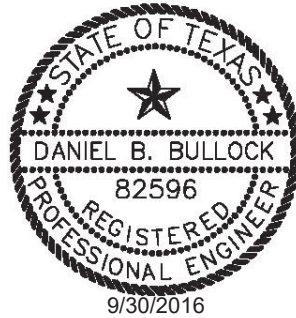

Attachments

LUMINANT

LUMINANT

ATTACHMENT 1

Landfill Cover Slope Stability Analysis

Slide 7.0 Analysis of Clay Cap

LUMINANT

# Monticello Bottom Ash Ponds - Effective Stress Analysis

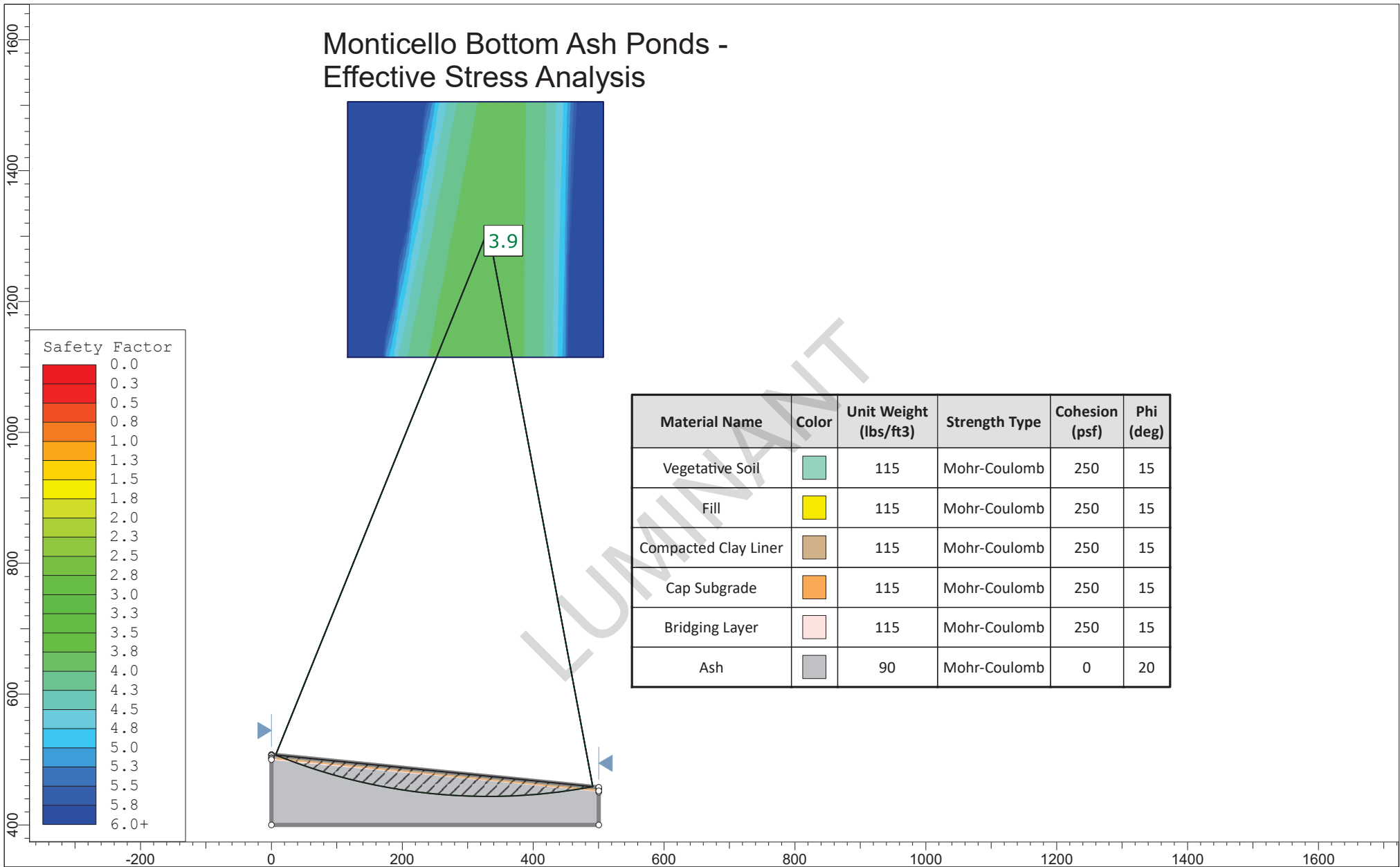

# Monticello Bottom Ash Ponds Cap - Total Stress Analysis

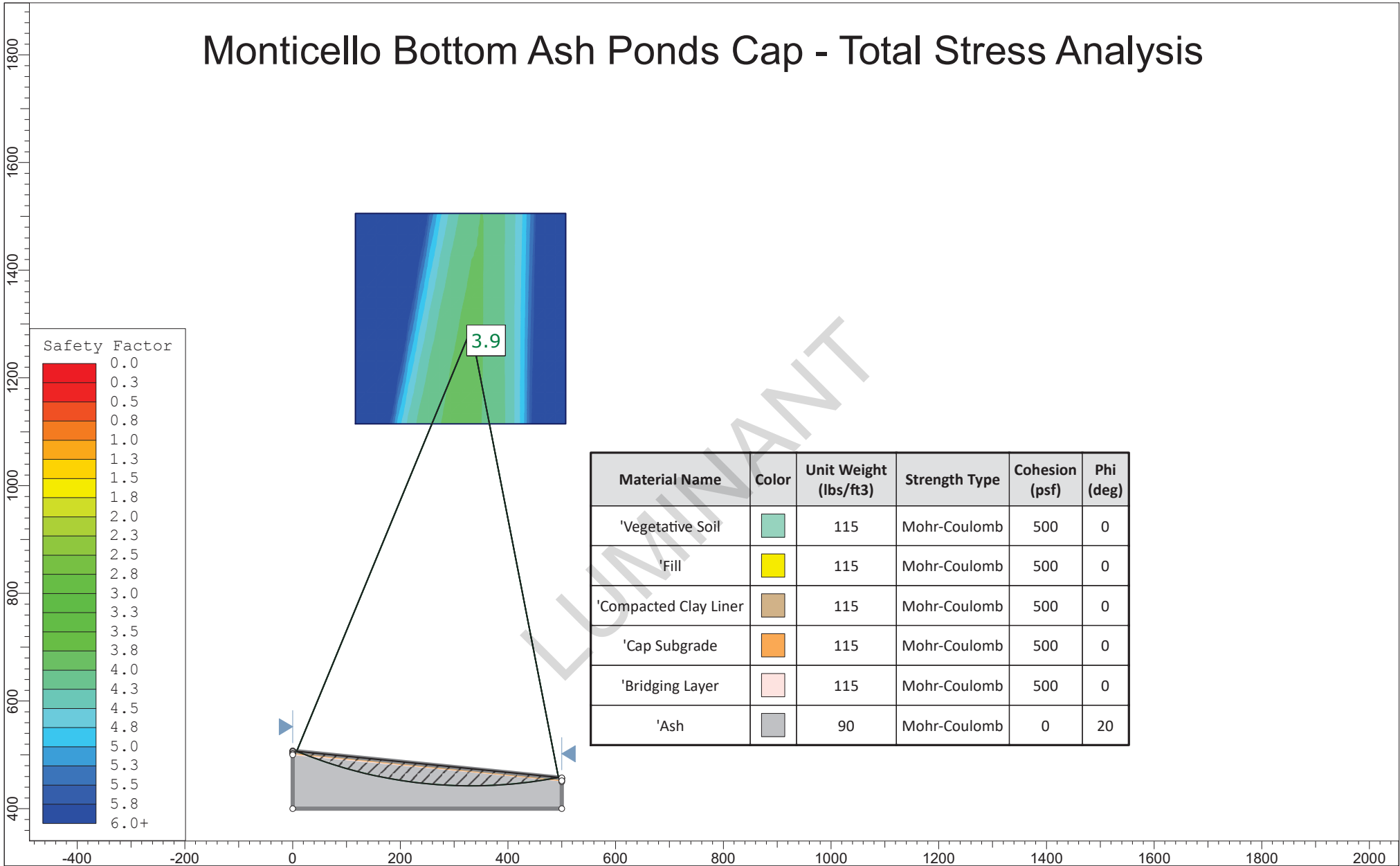

Veneer Cover Soil Analysis of Synthetic Cap System

LUMINANT

**LANDFILL COVER SLOPE STABILITY ANALYSIS - BOTTOM ASH PONDS**  
**Monticello Steam Electric Station, Titus County, Texas**

DEFINITION OF TERMS

Wa	Total weight of active wedge
Wp	Total weight of passive wedge
Na	Effective force normal to the failure plane of the active wedge
Np	Effective force normal to the failure plane of the passive wedge
Y	Unit weight of the cover soil
h	Thickness of the cover soil
L	Length of slope measured along the geomembrane
B	Soil slope angle beneath the geomembrane
Phi	Friction angle of the cover soil
Delta	Interface friction angle between cover soil and geomembrane
Ca	Adhesive force between cover soil of the active wedge and the geomembrane
ca	Adhesion between cover soil of the active wedge and the geomembrane
C	Cohesive force along the failure plane of the passive wedge
c	Cohesion of the cover soil
Ea	Interwedge force acting on the active wedge from the passive wedge
Ep	Interwedge force acting on the passive wedge from the active wedge, and
FS	Factor of safety against cover soil sliding on the geocomposite

EQUATIONS: (Designing with Geosynthetics (4th Edition), Robert M. Koerner)

$$W_a = Yh^2(L/h - 1/\sin B - \tan B/2) \quad (3.14)$$

$$N_a = W_a \cos B \quad (3.15)$$

$$W_p = Yh^2/\sin 2B \quad (3.17)$$

$$a = (W_a - N_a \cos B) \cos B$$

$$b = -[(W_a - N_a \cos B) \sin B \tan \Phi + (N_a \tan \Delta + C_a) \sin B \cos B + \sin B (C + W_p \tan \Phi)]$$

$$c = (N_a \tan \Delta + C_a) \sin^2 B \tan \Phi$$

$$FS = \frac{-b \pm \sqrt{b^2 - 4ac}}{2a} \quad (3.22)$$

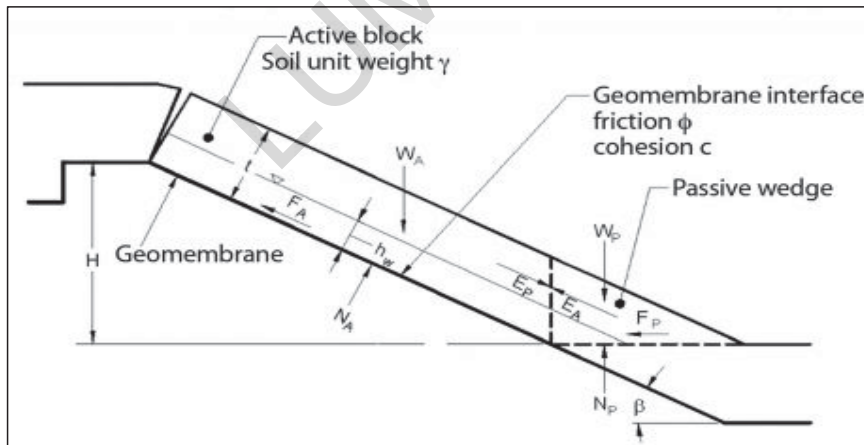

**FREE BODY DIAGRAM**

**LANDFILL COVER SLOPE STABILITY ANALYSIS - BOTTOM ASH PONDS**  
**Monticello Steam Electric Station, Titus County, Texas**

INPUT PARAMETERS:

<b>Delta</b>	19	21	23	25	27 degrees
<b>Y</b>	115	115	115	115	115 pcf
<b>Phi</b>	15	15	15	15	15 degrees
<b>h</b>	1.5	1.5	1.5	1.5	1.5 feet
<b>L</b>	500	500	500	500	500 feet
<b>B</b>	5.7	5.7	5.7	5.7	5.7 degrees
<b>Ca</b>	0	0	0	0	0
<b>ca</b>	0	0	0	0	0
<b>C</b>	0	0	0	0	0
<b>c</b>	0	0	0	0	0

CALCULATIONS:

<b>Wa</b>	83,631.86	83,631.86	83,631.86	83,631.86	83,631.86 lb/ft
<b>Wp</b>	1,309.08	1,309.08	1,309.08	1,309.08	1,309.08 lb/ft
<b>Na</b>	83,218.35	83,218.35	83,218.35	83,218.35	83,218.35 lb/ft
<b>a</b>	820.92	820.92	820.92	820.92	820.92
<b>b</b>	-2,888.67	-3,213.83	-3,547.83	-3,891.87	-4,247.31
<b>c</b>	75.99	84.71	93.67	102.91	112.44
<b>FS</b>	<u><b>3.49</b></u>	<u><b>3.89</b></u>	<u><b>4.30</b></u>	<u><b>4.71</b></u>	<u><b>5.15</b></u>

NOTES/ASSUMPTIONS:

- Assumes cap system includes, from bottom to top: 1 foot compacted clay subgrade, 40 mil textured FML, double-sided geocomposite drainage layer (geotextile on both sides), and 1.5 feet of vegetative cover soil.
- Assumes slopes of 10(h):1(v) (5.7deg).
- Assumes solid waste is stable (stability of waste not evaluated).
- Dynamic loading associated with construction or operations equipment were not evaluated. Use of construction methods protective of the liner system are assumed.
- Assumes effective lateral drainage layer and drained cover soil conditions prevents excess pore water pressure.
- Assumes no landfill gas migration into cap components.
- Interface friction angles between geotextile and soil, and between FML and geotextile are considered. For conservative evaluation purposes, no contribution of material tensile strengths, adhesion, or cohesion are considered for increased stability.
- Sensitivity analysis indicates very little effect on FS with moderate (plus or minus 10 pcf) change in soil unit weight and soil friction angle (plus or minus 10 degrees) parameters, but is very sensitive to variation in interface friction angles therefore, 5 different interface friction angles (19, 21, 23, 25, and 27) were evaluated. Typical values for interface friction angle are provided in attachments. GRI30 - Appendix Table 1 (Geosynthetics Research Institute, Direct Shear Database of Geosynthetic-to-Geosynthetic and Geosynthetic-to-Soil Interfaces - Koerner, Narejo, June 14, 2005) is attached.
- Assumes cover soil of uniform thickness and constant unit weight. Unit weight of 115 pcf, and friction angle of 15 degrees assumed.
- Due to lack of available on-site soil data, generalized soil engineering properties were assumed. A general range of synthetic material interface friction angles (with soil and other synthetic materials) were also assumed. Use of actual on-site soil materials and proposed synthetic materials for follow up laboratory testing and slope stability analysis is recommended prior to construction. Testing should include interface friction angle (and internal friction angle, as appropriate) measurements for all materials.
- Maximum slope length of less than 500 feet measured from preliminary design drawings, 500 feet was conservatively used in calculations.



ATTACHMENT 2

GRI30 – Appendix Table 1

LUMINANT



***Geosynthetic Research Institute***

475 Kedron Avenue  
Folsom, PA 19033-1208 USA  
TEL (610) 522-8440  
FAX (610) 522-8441



**Direct Shear Database of  
Geosynthetic-to-Geosynthetic and Geosynthetic-to-Soil Interfaces**

by

**George R. Koerner, Ph.D., P.E.  
Geosynthetic Research Institute  
Folsom, PA 19033-1208  
gkoerner@dca.net**

and

**Dhani Narejo, Ph.D.  
GSE Lining Technology, Inc.  
Houston, TX 77073  
dnarejo@gseworld.com**

**GRI Report #30**

**June 14, 2005**

Appendix Table 1. Summary of interface shear strengths.

Interface 1*	Interface 2*	Peak Strength					Residual Strength				
		Fig. No.	$\delta$ (deg)	Ca (kPa)	Points	R <sup>2</sup>	Fig. No.	$\delta$ (deg)	Ca (kPa)	Points	R <sup>2</sup>
HDPE-S	Granular Soil	1a	21	0	162	0.93	1b	17	0	128	0.92
HDPE-S	Cohesive Soil										
	Saturated	1c	11	7	79	0.94	1d	11	0	59	0.95
	Unsaturated	1c	22	0	44	0.93	1d	18	0	32	0.93
HDPE-S	NW-NP GT	1e	11	0	149	0.93	1f	9	0	82	0.96
HDPE-S	Geonet	1g	11	0	196	0.90	1h	9	0	118	0.93
HDPE-S	Geocomposite	1i	15	0	36	0.97	1j	12	0	30	0.93
HDPE-T	Granular Soil	2a	34	0	251	0.98	2b	31	0	239	0.96
HDPE-T	Cohesive Soil										
	Saturated	2c	18	10	167	0.93	2d	16	0	150	0.90
	Unsaturated	2c	19	23	62	0.91	2d	22	0	35	0.93
HDPE-T	NW-NP GT	2e	25	8	254	0.96	2f	17	0	217	0.95
HDPE-T	Geonet	2g	13	0	31	0.99	2h	10	0	27	0.99
HDPE-T	Geocomposite	2i	26	0	168	0.95	2j	15	0	164	0.94
LLDPE-S	Granular Soil	3a	27	0	6	1.00	3b	24	0	9	1.00
LLDPE-S	Cohesive Soil	3c	11	12.4	12	0.94	3d	12	3.7	9	0.93
LLDPE-S	NW-NP GT	3e	10	0	23	0.63	3f	9	0	23	0.49
LLDPE-S	Geonet	3g	11	0	9	0.99	3h	10	0	9	1.00
LLDPE-T	Granular Soil	4a	26	7.7	12	0.95	4b	25	5.2	12	0.95
LLDPE-T	Cohesive Soil	4c	21	5.8	12	1.00	4d	13	7.0	9	0.98
LLDPE-T	NW-NP GT	4e	26	8.1	9	1.00	4f	17	9.5	9	0.96
LLDPE-T	Geonet	4g	15	3.6	6	0.97	4h	11	0	6	0.98
PVC-S	Granular Soil	5a	26	0.4	6	0.99	5b	19	0	6	0.99
PVC-S	Cohesive Soil	5c	22	0.9	11	0.88	5d	15	0	9	0.95
PVC-S	NW-NP GT	5e	20	0	89	0.91	5f	16	0	83	0.74
PVC-S	NW-HB GT	5g	18	0	3	1.00	5h	12	0.1	3	1.00
PVC-S	Woven GT	5i	17	0	6	0.54	5j	7	0	6	0.93
PVC-S	Geonet	5k	18	0.1	3	1.00	5l	16	0.6	3	1.00

Appendix Table 1. (continued)

Interface 1*	Interface 2*	Peak Strength					Residual Strength				
		Fig. No.	$\delta$ (deg)	Ca (kPa)	Points	R <sup>2</sup>	Fig. No.	$\delta$ (deg)	Ca (kPa)	Points	R <sup>2</sup>
PVC-F	NW-NP GT	6a	27	0.2	26	0.95	6b	23	0	26	0.95
PVC-F	NW-HB GT	6c	30	0	8	0.97	6d	27	0	8	0.90
PVC-F	Woven GT	6e	15	0	6	0.78	6f	10	0	6	0.76
PVC-F	Geonet	6g	25	0	11	1.00	6h	19	0	11	0.99
PVC-F	Geocomposite	6i	27	1.1	5	1.00	6j	22	4.7	6	1.00
CSPE-R	Granular Soil	7a	36	0	3	1.00	7b	16	0	3	1.00
CSPE-R	Cohesive Soil	7c	31	5.7	6	0.71	7d	18	0	6	0.99
CSPE-R	NW-NP GT	7e	14	0	6	0.97	7f	10	0	6	0.98
CSPE-R	NW-HB GT	7g	21	0	3	1.00	7h	10	0	3	1.00
CSPE-R	Woven GT	7i	11	0	6	0.92	7j	11	0	3	1.00
CSPE-R	Geonet	7k	28	0	9	0.87	7l	16	0	9	0.80
NW-NP GT	Granular Soil	8a	33	0	290	0.97	8b	33	0	117	0.96
NW-HB GT	Granular Soil	8c	28	0	6	0.99	8d	16	0	6	0.91
Woven GT	Granular Soil	8e	32	0	81	0.99	8f	29	0	28	0.98
NW-NP GT	Cohesive Soil	9a	30	5	79	0.96	9b	21	0	28	0.79
NW-HB GT	Cohesive Soil	9c	29	0.9	15	0.71	9d	10	0	15	0.83
Woven GT	Cohesive Soil	9e	29	0	34	0.94	9f	19	0	16	0.86
GCL Reinforced (internal)	N/A	10a	16	38	406	0.85	10b	6	12	182	0.91
GCL (NW-NP GT)	HDPE-T	11a	23	8	180	0.95	11b	13	0	157	0.90
GCL (W-SF GT)	HDPE-T	11c	18	11	196	0.96	11d	12	0	153	0.92
Geonet	NW-NP GT	12a	23	0	52	0.97	12b	16	0	32	0.97
Geocomposite (NW-NP GT)	Granular Soil	13a	27	14	14	0.86	13b	21	8	10	0.92

**APPENDIX D**  
**STORMWATER HYDROLOGY CALCULATIONS**

LUMIVANT

**Summary of Peak Flow Estimate - SCC TR-55 Method  
Luminant - Bottom Ash Ponds - MOSES**

SCS TR-55 Equation & Variables	
$Q_p = Q_u \cdot \text{Area (miles}^2) \cdot Q \cdot F_p$	
$Q_p = \text{Estimated Peak Discharge (cfs)}$	$Q = (P - I_a)^2 / (P - I_a + S)$
$Q_u = \text{Unit Peak Discharge (cfs/mile}^2\text{-inch)}$	$P = \text{Design Storm Rainfall (inches)}$
$A = \text{Area (square miles)}$	$I_a = 0.2S \text{ (Initial abstractions; inches)}$
$Q = \text{Rainfall Excess (Depth of Runoff Over Watershed)}$	$S = 100 / \text{CN} - 10$
$F_p = \text{Ponding Factor (\% of ponds/swamps)}$	$\text{CN} = \text{SCS Curve Number}$

Drainage Area I.D.	Area (acres)	Area (mi <sup>2</sup> )	Composite Curve Number	Estimated Peak Flow (CFS) $Q_p$	P (25yr,24hr)	S	$I_a$	Q	$I_a/P$	TIME OF CONCENTRATION ESTIMATE								$Q_u$	$F_p$	
										$v1 = aS^{.5}$ fps	$v2$	Cap/Overland Flow $T_t$ (Min.)	Conc. Flow $T_t$ (Min.)	Estimated Time of Concen. (Min.)	CAP Roughness Coeff (Table 3.20)	CAP Roughness Coeff (Table 3.20)	Cap Slope (ft/ft)			Conc. Flow Slope (ft/ft)
WP-1	11.4	0.0178	86	51	7.9	1.63	0.33	6.23	0.04	0.43	0.88	12	11.34001	23	2.5	16.1	0.03	0.003	457.4	1
WP-2	2.5	0.0039	86	14	7.9	1.63	0.33	6.23	0.04	0.43	-	12	0	12	2.5		0.03		571.1	1
WP-3	2.5	0.0039	86	14	7.9	1.63	0.33	6.23	0.04	0.43	-	12	0	12	2.5		0.03		571.1	1
NEP-1	1.6	0.0025	86	9.4	7.9	1.63	0.33	6.23	0.04	0.43	-	9	0	9	2.5		0.03		604.9	1
NEP-2	1.6	0.0025	86	9.4	7.9	1.63	0.33	6.23	0.04	0.43	-	9	0	9	2.5		0.03		604.9	1
NEP-3	1.6	0.0025	86	9.4	7.9	1.63	0.33	6.23	0.04	0.43	-	9	0	9	2.5		0.03		604.9	1
CMB-1	2.1	0.0033	86	11	7.9	1.63	0.33	6.23	0.04	0.43	1.34	12	4.47205	16	2.5	16.1	0.03	0.006944	518.0	1
CMB-2	2.1	0.0033	86	11	7.9	1.63	0.33	6.23	0.04	0.43	1.34	12	4.47205	16	2.5	16.1	0.03	0.006944	518.0	1

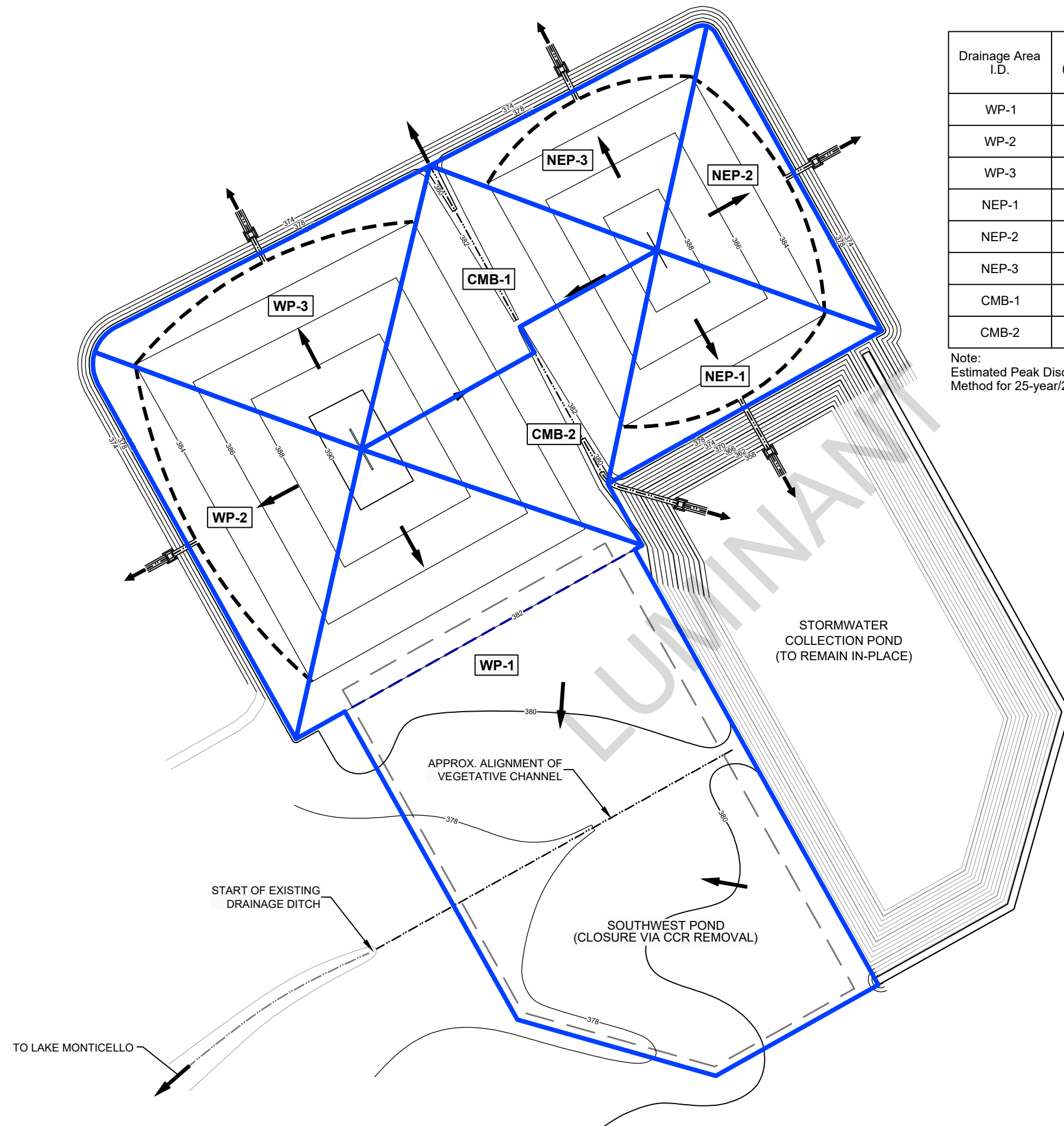

Drainage Area I.D.	Area (Acres)	Composite Curve No.	Estimated Peak Flow (CFS)
WP-1	11.4	86	51
WP-2	2.5	86	14
WP-3	2.5	86	14
NEP-1	1.6	86	9.4
NEP-2	1.6	86	9.4
NEP-3	1.6	86	9.4
CMB-1	2.1	86	11
CMB-2	2.1	86	11

Note:  
Estimated Peak Discharge based on SCS Curve Number Method for 25-year/24-hour storm event.

### EXPLANATION

- Proposed Finished Grade Contour 2 ft Interval
- Proposed Finished Grade Contour 10 ft Interval
- Limits of CAP
- Sheet Flow
- - - Concentration Flow Path
- - - Approximate Alignment Stormwater Diversion Berm
- Storm Water Drainage Divide



Scale in Feet  
0 90 180

LUMINANT GENERATION COMPANY, LLC  
MONTICELLO STEAM ELECTRIC STATION

Appendix D

## CCR COVER SYSTEM DRAINAGE AREAS AND ESTIMATED PEAK DISCHARGE

PROJECT: 5196A	BY: AJD	REVISIONS
DATE: SEPT., 2016	CHECKED: BDT	

PASTOR, BEHLING & WHEELER, LLC  
CONSULTING ENGINEERS AND SCIENTISTS

**APPENDIX E**  
**PROJECT SCHEDULE – CCR CLOSURE PROCESS**

LUMINANT



**APPENDIX E  
PROJECT SCHEDULE - CCR UNIT CLOSURE PROCESS**

Wed 9/28/16

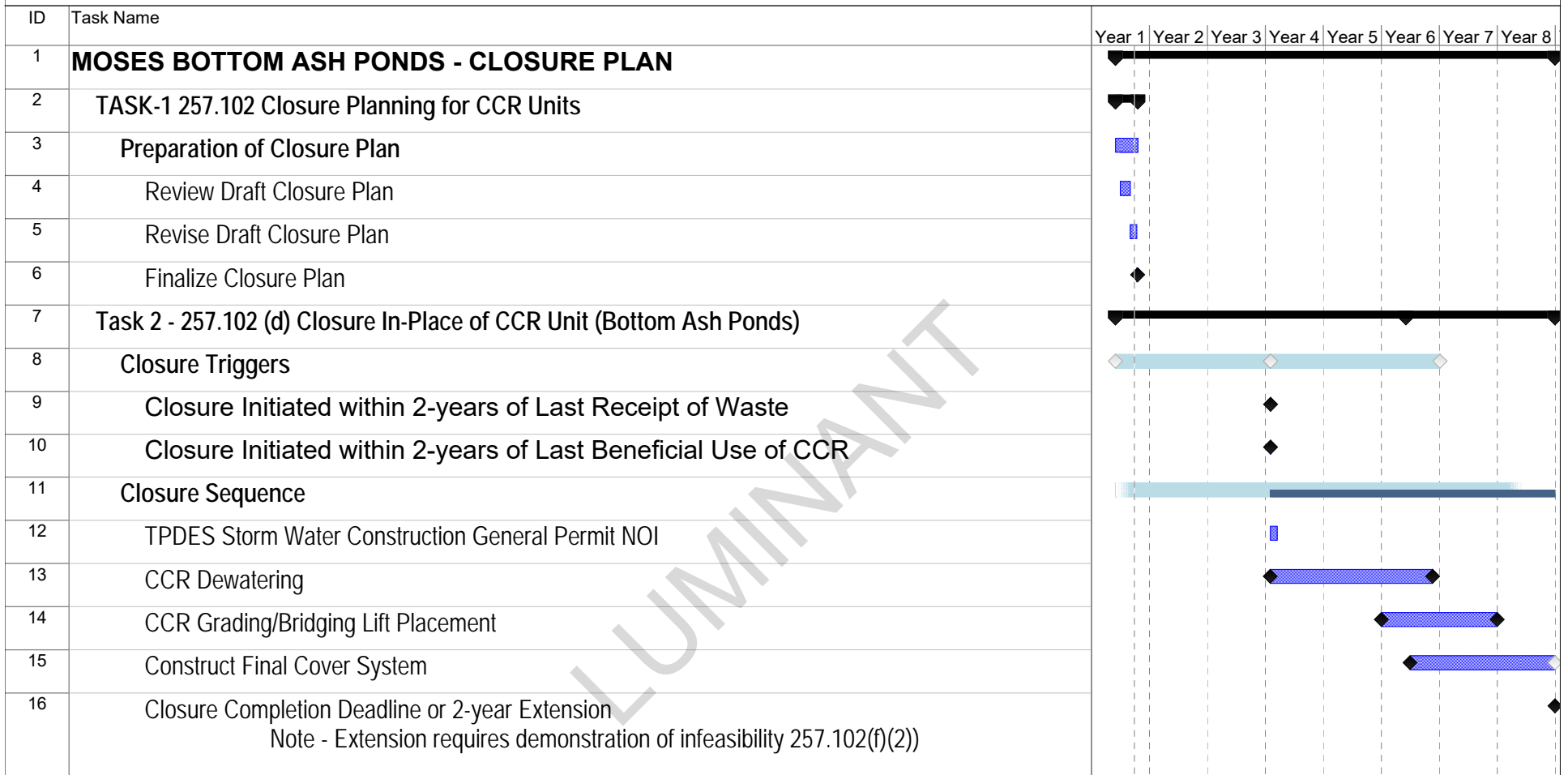

Page 1	Task		Inactive Task		Manual Summary	
	Split		Inactive Task		Start-only	
	Milestone		Inactive Milestone		Finish-only	
	Summary		Inactive Summary		Progress	
	Project Summary		Manual Task		Deadline	
	External Tasks		Duration-only			
	External Milestone		Manual Summary Rollup			

Notes: Schedule does not include administrative/legal/receiver activities. Closure initiation will be determined in accordance with the CCR Rule and this timeline only illustrates the anticipated construction sequencing following closure initiation.